

# InDesign Publishing Engine 1.2 Reference Manual

*Complete Reference to Sitecore Adaptive Print Studio*



## Table of Contents

Chapter 1	Overview . . . . .	5
Chapter 2	Introduction . . . . .	6
	2.1 Process Overview . . . . .	7
Chapter 3	Document Elements . . . . .	8
	3.1 Project Element . . . . .	9
	3.2 Book Element. . . . .	10
	3.3 Document Element . . . . .	13
Chapter 4	Page Elements . . . . .	15
	4.1 Page Element . . . . .	16
	4.2 TextFrame Element . . . . .	17
	4.3 ImageFrame Element . . . . .	20
	4.4 Image Element. . . . .	23
	4.5 Ellipse Element . . . . .	25
	4.6 Rectangle Element. . . . .	28
	4.7 Line Element . . . . .	31
	4.7.1 LinePoint Element. . . . .	33
Chapter 5	Content Elements . . . . .	34
	5.1 ParagraphStyle Element . . . . .	35
	5.2 CharacterStyle Element . . . . .	36
	5.3 SpecialCharacter Element . . . . .	37
	5.4 InsertVar Element . . . . .	38
	5.4.1 Using the InsertVar Element in a Table of Contents. . . . .	38
	5.4.2 Using the InsertVar Element in an Index . . . . .	44
Chapter 6	Tables . . . . .	47
	6.1 Table Element . . . . .	48
	6.2 Row Element . . . . .	49
	6.3 Cell Element. . . . .	50
Chapter 7	Inline Frames . . . . .	52
	7.1 Inline Element . . . . .	53
Chapter 8	Flow Elements. . . . .	57
	8.1 Flow Element . . . . .	58
	8.2 Footnote Element. . . . .	60
Chapter 9	Style Elements . . . . .	63
	9.1 Preferences . . . . .	64
	9.2 Colors. . . . .	65
	9.3 Layer Element . . . . .	66
	9.4 Style Element. . . . .	67
Chapter 10	Special Elements . . . . .	72
	10.1 Variable Element . . . . .	73



# Chapter 1

## Overview

This document describes the XML structure used by the Publishing Engine of Adaptive Print Studio. The document contains the following chapters:

- **Chapter 1 - Overview**
- **Chapter 2 - Introduction**  
This chapter introduces some basic principles when publishing InDesign documents using the Sitecore Publishing Engine.
- **Chapter 3 - Document Elements**  
This chapter describes the elements that build the basic project and document structure.
- **Chapter 4 - Page ElementsPage Elements**  
This chapter describes the elements used to define pages and page objects.
- **Chapter 5 - Page ElementsContent Elements**  
This chapter describes the content elements that can be used within a text frame, table cell or Inline frame.
- **Chapter 6 - Page ElementsTables**  
This chapter describes the elements involved with creating InDesign tables
- **Chapter 7 - Page ElementsInline Frames**  
This chapter describes the elements involved with creating Inline frames.
- **Chapter 8 - Page ElementsFlow Elements**  
This chapter describes how to work with a flow type production and the footnote element.
- **Chapter 9 - Page ElementsStyle Elements**  
This chapter describes how to work with style elements.
- **Chapter 10 - Page ElementsSpecial Elements**  
This chapter describes how to work with variables.

## Chapter 2

### Introduction

This chapter introduces some basic principles when publishing InDesign documents using the Sitecore Publishing Engine.

## 2.1 Process Overview

The following diagram explains the overall process.

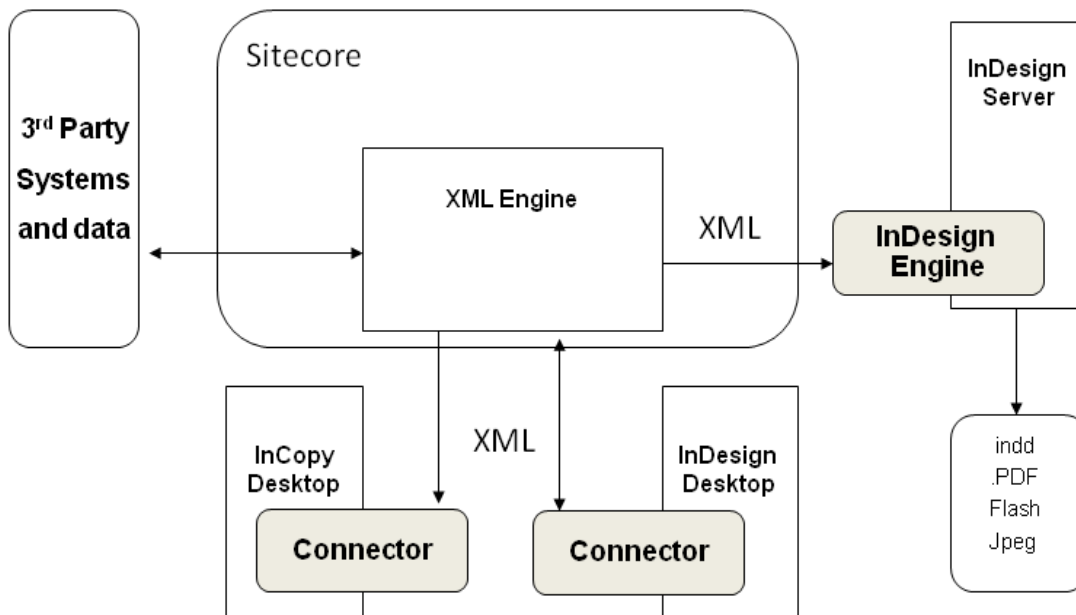

## Chapter 3

# Document Elements

This chapter describes the elements that build the basic project and document structure.

This chapter contains the following sections:

- Project Element
- Book Element
- Document Element



## 3.1 Project Element

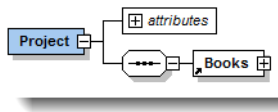

### Project

Attribute	Def <sup>a</sup>	Value(s)	Def. value	Explanation/examples
Units	I	mm points	points	The units of measurement for the project (for font settings points are used always). Values points or mm, when no value is inserted or the attribute is not included the "points" value will be used.
CloseProject	I	True False	True	Redundant

a.R=Required, I=Implied

## 3.2 Book Element

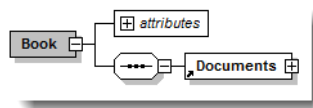

### Book

Attribute	Def <sup>a</sup>	Value(s)	Default Value	Explanation/examples
CreateBook	I	True False	False	True a book file is created. False no book file is created.
UseHighRes	I	True False	False	False LowResSrc full dos path (c:\.\name.gif) is used for publishing. True HighResSrc full dos path (c:\.\name.tiff) is used for publishing.
AutoUpdate	I	True False	True	Update the book file according to page order.
BlankPage	I	True False	False	Add blank InDesign page to document.
BookFilename	I			See note 1 at the end of this table.
ConvertVars	I	True False	False	False index variables are not converted to text. True the variable will be converted.
ExportPDF	I	True False	False	Export the book file to PDF or not. True a PDF file of the book is created
ExportSWF	I	True False		Export to swf format when set to True
name	I			Name of item
PageOrder	I	Odd Even Previous	Odd	The page order start number: Previous means start from previous document in book Odd means start on odd page Even means start on even page
PDFExportSetting	I			Value is the desired PDF export setting for books or documents.
PDFFilename	I			The full dos path (c:\.\name.pdf) of the InDesign book.
PrintBook	I	True False	False	Print the entire book.
PrintPreset	I			The printer settings to use when printing the book using "PrintBook".
Repaginate	I			Only used internally by InDesign connector plug-in
SitecoreID	I			The unique ID of the item
SWFFilename	I			The filename to use for the SWF file.
PageCurl	I	True False	True	If True page curl is enabled.
CurveQuality	I	0 .. 100	80	Sets the curve quality for the export.
SpineGradient	I	True False	True	If True, 'page spine' gradient is shown even when no page curl is in progress.
ShowCornerTease	I	True False	True	True a teaser animation is shown if user mouses over a corner.
EdgePercentage	I	0 .. 100	50	Integer. Real value indicating percentage of width/height for grabber area size.
MediaHandling	I	IncludeAll AppearanceOnly	IncludeAll	Sets the preferred method for handling dynamic media page items.
FrameRate	I	0 .. 100	24	Integer Set the frame rate for the generated SWF.

**Book (Continued)**

Attribute	Def <sup>a</sup>	Value(s)	Default Value	Explanation/examples
GenerateHTML	l	True False	True	Set to True, a HTML file is generated as well.
TranspBack	l	True False	False	Has transparent background (when transparent background, page curl is not possible) when set to True.
IncludePreloader	l	True False	True	Include preloader when set to True.
JpegQuality	l	Minimum Low Medium High Maximum	Medium	Set the jpeg quality.
Compression	l	Automatic Lossless JPEG	Automatic	Set the compression.
Resolution	l	0 .. ∞	72	Integer. Values in dpi Sets the preferred raster resolution for the export.
Spreads	l	True False	False	Sets whether to export as reader's spreads.
Threshold	l		72	Integer. Values in dpi Sets the raster resolution threshold.
ResamplingType	l	None Average Subsample Bicubic	Average	Sets the algorithm to be used for resampling raster images that exceed the specified resolution threshold.
Sizing	l	Scale Size FitTo	Scale	Set the scale and fit settings to be applied for the export. Scale set scaling percentage Size set the exact width and height FitTo fit to screen resolution
FitToValue	l	1280 x 800 984 x 588 800 x 600 760 x 420 640 x 480 600 x 300	1280 x 800	Set the value when Sizing is set to FitTo. Values in ppi
Height	l	0 .. 100	100	Real numbers. Set the height when Sizing is set to Size.
Width	l	0 .. 100	100	Real numbers. Set the width when Sizing is set to Size.
TextExport	l	Vectorize Live Rasterize Vellum	Vectorize	Sets the text export policy for all text frame dictating how text is to be represented in the exported file.
Transparency	l	Ignore Flatten Native	Ignore	Sets the preferred method for handling transparency on a page or spread, if it exists.
UseNetwork	l	True False	True	Set whether to allow using network access in generated SWF.
ViewAfterExport	l	True False	False	Sets whether to view the generated SWF file after exporting.
UpdateBook	i	True False	True	If set to true or left empty, will effect to book update.

a.R=Required, I=Implied

**Note 1:**

- If CreateBook=True, a book file is created. When CreateBook=True and ExportPDF=True, a PDF file of the book is created.
- If CreateBook=True, there is never a PDF file or SWF file created of the document. If CreateBook = False and ExportPDF = True, a PDF of the (first) document is created.
- If CreateBook = False and ExportSWF = True, flash of the (first) document is created.

The different filenames (indb, PDF and SWF) are compiled based on the following logic:

- If the specific attribute (BookFileName, PDFFileName and SWFFilename) has a value, that value is used for the filename.

If a value is left empty:

- The indb (book) filename = value of "OutputFolder" + value of "name" + value of "SitecoreID" + ".indb"
- The PDF filename = value of "OutputFolder" + value of "name" + value of "SitecoreID" + ".pdf"
- The SWF filename = value of "OutputFolder" + value of "name" + value of "SitecoreID" + ".pdf"

Outputfolder is derived from XML source file location.

If "name" is empty or attribute does not exist, the name is set to some default.

If "SitecoreID" is empty or attribute does not exist a unique ID is generated

### 3.3 Document Element

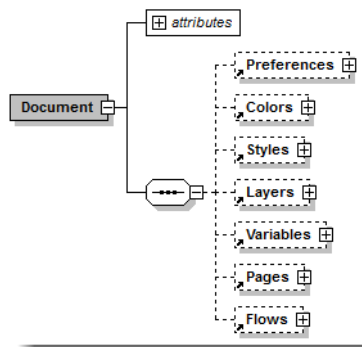

#### Document

Attribute	Def <sup>a</sup>	Value(s)	Def. value	Explanation/examples
Name	I			The document filename (indd) is compiled based on the following logic: If the DocFilename attribute has a value, that value is used for the filename.  If a value is left empty: The indd filename = value of "OutputFolder" + value of "name" + value of "SitecoreID" + ".indb"  Outputfolder is derived from XML source file location. If "name" is empty, the name is set to some default.
name	I			Name of the item.
SitecoreID	I			The unique ID of the item. If "SitecoreID" is empty a unique ID is generated.
Type	I	Static Dynamic	Dynamic	The document type. Dynamic means document created from XML, Static means static InDesign document. When using Static the engine will use the document referred in the MasterFilename attribute and will save this document using the filename stated in the DocFilename attribute.
PageWidth	I			The width of the pages specified in the amount of specified units of measurement.
PageHeight	I			The height of the pages specified in the amount of specified units of measurement.
Bleed	I			The amount of bleed.
MasterFilename	R			The full dos path (c:\.name.indd) of the master document to use for this document. If left empty a new document is created using no master file.
DocFilename	R			The full dos path (c:\.name.indd) of the document to create/or use for this document. If left empty the filename is compiled using the name and SitecoreID attribute values. If those are left out or empty, the name is compiled using a unique identifier.
InsertFile	I			Not supported using the Adaptive Print Studio.
SaveAs	I			Not supported using the Adaptive Print Studio.
PageCount	I			The page count is driven by inserted value (No value means as is in XML, Odd means document always ends on odd page, Even means document always ends on even page.
ScriptFilename	I			Full path of an InDesign script added to document. For additional information we refer to the Adobe website/SDKs.
WaterMark	I		False	If set to True, a watermark is printed across all pages in the document.
MarkText	I		Default watermark	The watermark text.

**Document (Continued)**

Attribute	Def <sup>a</sup>	Value(s)	Def. value	Explanation/examples
MarkFontSize	I		58	The watermark text font size.
MarkFontColor	I		#555555	The font color in rgb (#rrggbb). For example #rrggbb (ff0000), which is red.
Shuffle	I	True False	True	If field is left empty, the master document settings are used.

a.R=Required, I=Implied

## Chapter 4

### Page Elements

This chapter describes the elements used to define pages and page objects.

This chapter contains the following sections:

- Page Element
- TextFrame Element
- ImageFrame Element
- Image Element
- Ellipse Element
- Rectangle Element
- Line Element

## 4.1 Page Element

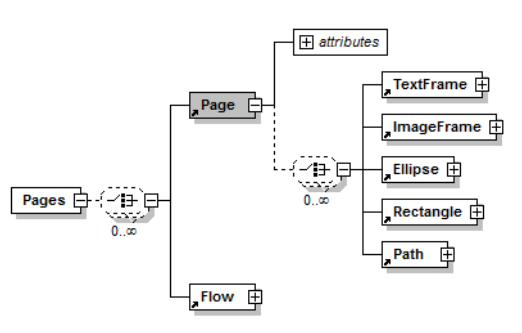

### Page

Attribute	Def <sup>a</sup>	Value(s)	Def. value	Explanation/examples
name	I			Only used for internal purposes by InDesign connector.
SitecoreID	R			The SitecoreID attribute is used to identify each page object (Textframe, ImageFrame, etc) with a corresponding Sitecore item. The SitecoreID attribute contains the ID value of that specific item. Each page object item created with the InDesign connector is related to a Sitecore item.  Note: When using a script to create a page object (Textframe, ImageFrame, etc), you should add the SitecoreID attribute and use a default value (e.g. "null") so the InDesign connector can identify this item.
Number	R			The number used to identify the page. If a page exists, the page objects are added to that specific page. If it does not exist, a new page is created and the page objects are added to that new page.
MasterPrefix	R			For InDesign for example "A", "B" and so on.
MasterBase	R			For InDesign for example "Master".
Transition	I	Blinds Box Comb Cover Dissolve Fade PageTurn Push Split Uncover Wipe ZoomIn ZoomOut	None	Sets the page transition.
Direction	I	Down Left LeftDown LeftUp Right RightDown RightUp Up In Out Horizontal Vertical HorizontalIn HorizontalOut VerticalIn VerticalOut	None	Sets the transition direction.
Speed	I	Slow Medium Fast	Default time	Sets the transition speed.
ContNr	I	True False	True	If the attribute is not specified, the value is taken from the master document.



a.R=Required, I=Implied

## 4.2 TextFrame Element

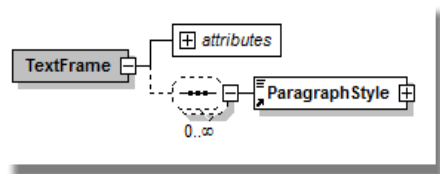

### TextFrame

Attribute	Def	Value(s)	Def. value	Explanation/examples
Width	R			The width of the graphic frame in the specified units.
Height	R			The height of the graphic frame in the specified units.
X	R			The horizontal position of the center point of the graphic frame with reference to the left corner point of the page in the specified units.
Y	R			The vertical position center point of the graphic frame with reference to the left corner point of the page in the specified units.
Stroke	I			The stroke color in swatch or "#rrggbb" or cmyk "c=0;m=100;y=100;k=0;". Value of "None" mean no stroke. If a swatch is used and the swatch does not exist in the master document, it will be created using default color values.
StrokeThickness	I			The thickness of the stroke in points.
StrokeType	I	Solid ThickThick ThickThin ThickThinThick ThinThick ThinThickThin ThinThin Triple_Stroke Canned Dashed 3x2 Canned Dashed 4x4 Left Slant Hash Right Slant Hash Straight Hash Canned Dotted Wavy White Diamond Japanese Dots  Dashed	Solid	Stroke values
Z-Index	R			The z-index of the graphic frame. Can be used to move a frame to the front/back. If the z-index is unknown, use any value like for example 0.
Background	I			Background color in swatch or "#rrggbb" or cmyk "c=0;m=100;y=100;k=0;". Value of "None" mean no stroke. If a swatch is used and the swatch does not exist in the master document, it will be created using default color values.
LayerName	R			The name of the layer where the graphic frame is put on. If the layer does not exist, it is created using defaults.
Rotation	I			The rotation of the graphic frame rotated round the centre middle. In degrees.
VerticalAlignment	I	Top Middle Bottom Justify	Top	The vertical alignment of the content in the text frame.
Opacity	I			The opacity in percentage (values from 0 to 100) of the frame. When value is "0" no fill color is shown (means 0%) When the attribute is not used the standard InDesign value is used.

## TextFrame

Attribute	Def	Value(s)	Def. value	Explanation/examples
Transparency	I			The transparency of the graphic frame (as in InDesign). When value is "0" no fill color is shown (means 0%) When the attribute is not used the standard InDesign value is used.
Name	I			Only used internally by the InDesign connector.
CornerRadius	I			The corner effects setting in the specified units of the graphic frame.
CornerType	I	None Rounded Inverse Rounded Inset Bevel Fancy		The corner effect setting of the graphic frame. Ex: None None None None
margin-left	I			Left margin in the specified units.
margin-top	I			Top margin in the specified units.
margin-right	I			Right margin in the specified units.
margin-bottom	I			Bottom margin in the specified units.
Id	I			Only used internally.
Identifier	I			Only used internally.
FlowName	I			Name of the flow used for threaded text frames.
FlowOrder	I			The order of the text frame in the entire flow.
SitecoreID	R			The SitecoreID attribute is used to identify each page object (Textframe, ImageFrame, etc) with a corresponding Sitecore item. The SitecoreID attribute contains the ID value of that specific item. Each page object item created with the InDesign connector is related to a Sitecore item.  Note: When using a script to create a page object (Textframe, ImageFrame, etc), you should add the SitecoreID attribute and use a default value (e.g. "null") so the InDesign connector can identify this item.
SitecoreFieldname	I			Only used internally.
HorizontalScale	I			Value - / +. Value of 0.8 means scale to 80%. Value of 2 means 200%. HorizontalScale and VerticalScale always need to be set both in order to use scaling.
VerticalScale	I			Value - / +. Value of 0.8 means scale to 80%. Value of 2 means 200%. HorizontalScale and VerticalScale always need to be set both in order to use scaling.
Skew	I	0-360		Value in degrees.
NrOfColumns	I			Value number of columns used for text frames.
ColumnGutter	I			Value of gutter between columns.
ObjectStyle	I			An InDesign Object Style can be used for formatting (effects). If the name of the Object Style used in the master is used as value of this attribute it will be applied. If the objectstyle does not exist, it is NOT created automatically.
ScriptOverflow	I			The full file(s) path. Script is executed when text overflow is encountered for the text frame. 3 parameters are sent to the script. par1 documentname par2 XML iD par3 InDesign GUID
RunOnce	I	True False	True	True the scriptoverflow is only run once. False the script is executed until no overflow is encountered.
RunScript	I			The full file(s) path. Three parameters are sent to the script. par1 documentname par2 XML iD par3 InDesign GUID

## TextFrame

Attribute	Def	Value(s)	Def. value	Explanation/examples
FitFrame	I	True False	False	True the frame is auto fitted according to the text in the frame.
ShowOverflow	I	True False	False	Show overflow indicator. Overflow frame uses "OverFlow" objectstyle and content uses "OverFlow" paragraphstyle. The calling frame gets a strokecolor called "OverFlow" Only works in InDesign server.
FillTint	I			The percentage of the tint for the background color.
StrokeTint	I			The percentage of the tint for the stroke color.
WMode	I	0 1 2 3 4 5 6 7 8		Wrap mode 0 no text wrap 1 jump object 2 jump to next column 3 wrap around bounding box 4 Invalid, unimplemented 5 Invalid, unimplemented 6 wrap around object shape 7 Invalid, unimplemented 8 Invalid, unimplemented
WOffset	I	top;left;bottom;right;single		Wrap offset Distance 1;2;1;2;0 Whether the item only supports one value for all sides (that is topMargin is the only valid margin) values 1/0
WInvert	I	0/1		Invert text wrap
WSide	I	0 1 2 3 4 5		Wrap side 0 Both left & right sides 1 Left side 2 Right side 3 Side Towards Spine 4 Side Away from Spine 5 Largest Area
WIgnore	I	1 0		Ignore textwrap (only for textframes) 1 Ignore textwrap
LCap	I	0 1 2		Line cap 0 But cap 1 Round cap 2 Projecting cap
JType	I	0 1 2		Join type 0 Miter join 1 Round join 2 Bevel join
MLim	I			Miter limit
SAlign	I	0 1 2		Stroke alignment 0 Align stroke to center 1 Align stroke to inside 2 Align stroke to outside
LEnd	I	Simple Bar SquareSolid Square CircleSolid Circle Curved Barbed TriangleWide Triangle SimpleWide		(Line end) and LStart (line start)
BalCols	I	True/False		Balance columns

## 4.3 ImageFrame Element

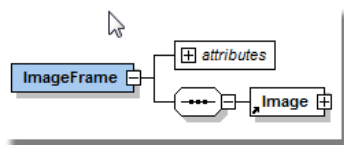

### ImageFrame

Attribute	Def <sup>a</sup>	Value(s)	Def. value	Explanation/examples
Width	R			The width of the graphic frame in the specified units.
Height	R			The height of the graphic frame in the specified units.
X	R			The horizontal position of the center point of the graphic frame with reference to the left corner point of the page in the specified units.
Y	R			The vertical position center point of the graphic frame with reference to the left corner point of the page in the specified units.
Stroke	I			The stroke color in swatch or "#rrggbb" or CMYK: "c=0;m=100;y=100;k=0;". Value of "None" mean no stroke. If a swatch is used and the swatch does not exist in the master document, it will be created using default color values.
StrokeThickness	I			The thickness of the stroke in points.
StrokeType	I	Solid ThickThick ThickThin ThickThinThick ThinThick ThinThickThin ThinThin Triple_Stroke Canned Dashed 3x2 Canned Dashed 4x4 Left Slant Hash Right Slant Hash Straight Hash Canned Dotted Wavy White Diamond Japanese Dots  Dashed	Solid	Stroke values.
Z-Index	R			The z-index of the graphic frame. Can be used to move a frame to the front/back. If the z-index is unknown, use any value like for example 0.
Background	I			Background color in swatch or "#rrggbb" or cmyk "c=0;m=100;y=100;k=0;". Value of "None" mean no stroke. If a swatch is used and the swatch does not exist in the master document, it will be created using default color values.
LayerName	R			The name of the layer where the graphic frame is put on. If the layer does not exist, it is created using defaults.
Rotation	I			The rotation of the graphic frame rotated round the centre middle. In degrees.
VerticalAlignment	I	Top Middle Bottom Justify	Top	The vertical alignment of the content in the text frame.
Opacity	I			The opacity in percentage (values from 0 to 100) of the graphic frame.
Transparency	I			The transparency of the graphic frame (as in Indesign).
Name	I			Frame label (not used for now).
CornerRadius	I			The corner effects setting in the specified units of the graphic frame.

## ImageFrame (Continued)

Attribute	Def <sup>a</sup>	Value(s)	Def. value	Explanation/examples
CornerType	I	None Rounded Inverse Rounded Inset Bevel Fancy		The corner effect setting of the graphic frame. Ex: None None None None
Margin-left	I			Left margin in the specified units.
Margin-top	I			Top margin in the specified units.
Margin-right	I			Right margin in the specified units.
Margin-bottom	I			Bottom margin in the specified units.
Id	I			Only used internally.
Identifier	I			Only used internally.
SitecoreID	R			The SitecoreID attribute is used to identify each page object (Textframe, ImageFrame, etc) with a corresponding Sitecore item. The SitecoreID attribute contains the ID value of that specific item. Each page object item created with the InDesign connector is related to a Sitecore item.  Note: When using a script to create a page object (Textframe, ImageFrame, etc), you should add the SitecoreID attribute and use a default value (e.g. "null") so the InDesign connector can identify this item.
SitecoreFieldname	I			Only used internally.
Scaling	I	None AsIs Fit Content to Frame Fit Frame to Content Center Content Fit Content Proportionally Fill Frame Proportionally Fill Frame Proportionally and Center Fit Content Proportionally and Center		Images can be scaled automatically by using the values of this attribute.  None use image width, height, x and y to position the image. AsIs place the image in its actual with and height.
HorizontalScale	I			Value - / +. Value of 0.8 means scale to 80%. Value of 2 means 200%. HorizontalScale and VerticalScale always need to be set both in order to use scaling.
VerticalScale	I			Value - / +. Value of 0.8 means scale to 80%. Value of 2 means 200%. HorizontalScale and VerticalScale always need to be set both in order to use scaling.
Skew	I			Value in degrees.
Center	I	True False	False	False do nothing True the image is placed as Indesign value "Center Content", attribute is used with scaling attributes.
FitFrame	I	True False	False	False do nothing True the frame is placed as Indesign value "Fit frame to Content", attribute is used with scaling attributes (values).
ObjectStyle	I			An InDesign Object Style can be used for formatting (effects). When the name of the Object Style used in the master is used as value of this attribute it will be applied. If the objectstyle does not exist, it is NOT created automatically.
RunScript	I			The full file(s) path. 3 Parameters are sent to the script. par1 documentname par2 XML iD par3 InDesign GUID
FillTint	I			The percentage of the tint for the background color.
StrokeTint	I			The percentage of the tint for the stroke color.

## ImageFrame (Continued)

Attribute	Def <sup>a</sup>	Value(s)	Def. value	Explanation/examples
WMode	I	0 1 2 3 4 5 6 7 8		Wrap mode. 0 no text wrap 1 jump object 2 jump to next column 3 wrap around bounding box 4 Invalid, unimplemented 5 Invalid, unimplemented 6 wrap around object shape 7 Invalid, unimplemented 8 Invalid, unimplemented
WOffset	I	top;left;bottom;right;single		Distance of wrap offset Ex: 1;2;1;2;0;  Whether the item only supports one value for all sides (that is topMargin is the only valid margin) values 1/0
WInvert	I	0/1		Invert text wrap
WSide	I	0 1 2 3 4 5		Wrap side 0 both left & right sides 1 Left side 2 Right side 3 Side Towards Spine 4 Side Away from Spine 5 Largest Area
LCap	I	0 1 2		Line cap 0 But cap 1 Round cap 2 Projecting cap
JType	I	0 1 2		Join type 0 Miter join 1 Round join 2 Bevel join
MLim	I			Miter limit
SAlign	I	0 1 2		Stroke alignment) 0 Align stroke to center 1 Align stroke to inside 2 Align stroke to outside
LEnd	I	Simple Bar SquareSolid Square CircleSolid Circle Curved Barbed TriangleWide Triangle SimpleWide		(Line end) and LStart (line start).

a.R=Required, I=Implied

## 4.4 Image Element

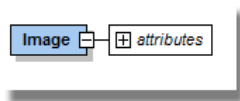

### Image

Attribute	Def <sup>a</sup>	Value(s)	Def. value	Explanation/examples
Width	R			The width of the graphic frame in the specified units.
Height	R			The height of the graphic frame in the specified units.
X	R			The horizontal position of the center point of the graphic frame with reference to the center point of the ImageFrame in the specified units.
Y	R			The vertical position center point of the graphic frame with reference to the center point of the ImageFrame in the specified units.
LowResSrc	R			The full dos path (c:\.\name.gif) of low resolution images.
HighResSrc	R			The full dos path (c:\.\name.tiff) of high resolution images.
Name	I			Only used internally.
Rotation	I			The rotation of the graphic frame rotated round the centre middle. In degrees.
Id	I			Only used internally.
Identifier	I			Only used internally.
SitecoreID	R			<p>The SitecoreID attribute is used to identify each page object (Textframe, ImageFrame, etc) with a corresponding Sitecore item. The SitecoreID attribute contains the ID value of that specific item. Each page object item created with the InDesign connector is related to a Sitecore item.</p> <p>Note: When using a script to create a page object (Textframe, ImageFrame, etc), you should add the SitecoreID attribute and use a default value (e.g. "null") so the InDesign connector can identify this item.</p>
SitecoreFieldname	I			Only used internally.
HorizontalScale	I			Value - / +. Value of 0.8 means scale to 80%. Value of 2 means 200%. HorizontalScale and VerticalScale always need to be set both in order to use scaling.
VerticalScale	I			Value - / +. Value of 0.8 means scale to 80%. Value of 2 means 200%. HorizontalScale and VerticalScale always need to be set both in order to use scaling.
Skew	I			Value in degrees.
ObjectStyle	I			An InDesign Object Style can be used for formatting (effects). When the name of the Object Style used in the master is used as value of this attribute it will be applied. If the objectstyle does not exist, it is NOT created automatically.
RunScript	I			<p>The full file(s) path. 3 parameters are sent to the script.</p> <pre>par1    document name par2    XML iD par3    InDesign GUID</pre>
Wmode	I	0 1 2 3 4 5 6 7 8		<p>Wrap mode.</p> <pre>0 No text wrap 1 Jump object 2 Jump to next column 3 Wrap around bounding box 4 Invalid, unimplemented 5 Invalid, unimplemented 6 Wrap around object shape 7 Invalid, unimplemented 8 Invalid, unimplemented</pre>

**Image (Continued)**

Attribute	Def <sup>a</sup>	Value(s)	Def. value	Explanation/examples
WOffset	I	top;left;bottom;right;single		Distance of wrap offset Ex: 1;2;1;2;0;  Whether the item only supports one value for all sides (that is topMargin is the only valid margin) values 1/0
WInvert	I	0/1		Invert text wrap
WSide	I	0 1 2 3 4 5		Wrap side 0 Both left & right sides 1 Left side 2 Right side 3 Side Towards Spine 4 Side Away from Spine 5 Largest Area
WCont	I	0 1 2 3 4 5	0	Wrap contour 0 Graphic Bounds 1 Detect Edges 2 Using Alpha Channel 3 Using Photoshop Path 4 Graphic Frame 5 SameAsClip

a.R=Required, I=Implied



## 4.5 Ellipse Element



### Ellipse

Attribute	Def <sup>a</sup>	Value(s)	Def. value	Explanation/examples
Width	R			The width of the graphic frame in the specified units.
Height	R			The height of the graphic frame in the specified units.
X	R			The horizontal position of the center point of the graphic frame with reference to the left corner point of the page in the specified units.
Y	R			The vertical position center point of the graphic frame with reference to the left corner point of the page in the specified units.
Stroke	I			The stroke color in swatch or "#rrggbb" or cmyk "c=0;m=100;y=100;k=0;". Value of "None" mean no stroke. If a swatch is used and the swatch does not exist in the master document, it will be created using default color values.
StrokeThickness	I			The thickness of the stroke in points.
StrokeType	I	Solid ThickThick ThickThin ThickThinThick ThinThick ThinThickThin ThinThin Triple_Stroke Canned Dashed 3x2 Canned Dashed 4x4 Left Slant Hash Right Slant Hash Straight Hash Canned Dotted Wavy White Diamond Japanese Dots  Dashed	Solid	Stroke values
Z-Index	R			The z-index of the graphic frame. Can be used to move a frame to the front/back. If the z-index is unknown, use any value like for example 0.
Background	I			Background color in swatch or "#rrggbb" or cmyk "c=0;m=100;y=100;k=0;". Value of "None" mean no stroke. If a swatch is used and the swatch does not exist in the master document, it will be created using default color values.
LayerName	R			The name of the layer where the graphic frame is put on. If the layer does not exist, it is created using defaults.
Rotation	I			The rotation of the graphic frame rotated round the centre middle. In degrees.
Opacity	I			The opacity in percentage (values from 0 to 100) of the graphic frame.
Transparency	I			The transparency of the graphic frame (as in Indesign).
Name	I			Only used internally.
CornerRadius	I			The corner effects setting in the specified units of the graphic frame.
CornerType	I	None Rounded Inverse Rounded Inset Bevel Fancy		The corner effect setting of the graphic frame (as in Indesign). Ex: None None None None
Id	I			Only used internally.

## Ellipse (Continued)

Attribute	Def <sup>a</sup>	Value(s)	Def. value	Explanation/examples
Identifier	I			Only used internally.
SitecoreID	R			The SitecoreID attribute is used to identify each page object (Textframe, ImageFrame, etc) with a corresponding Sitecore item. The SitecoreID attribute contains the ID value of that specific item. Each page object item created with the InDesign connector is related to a Sitecore item.  Note: When using a script to create a page object (Textframe, ImageFrame, etc), you should add the SitecoreID attribute and use a default value (e.g. "null") so the InDesign connector can identify this item.
SitecoreFieldname	I			Only used internally.
HorizontalScale	I			Value - / +. Value of 0.8 means scale to 80%. Value of 2 means 200%. HorizontalScale and VerticalScale always need to be set both in order to use scaling.
VerticalScale	I			Value - / +. Value of 0.8 means scale to 80%. Value of 2 means 200%. HorizontalScale and VerticalScale always need to be set both in order to use scaling.
Skew	I			Value in degrees.
ObjectStyle	I			An InDesign Object Style can be used for formatting (effects). When the name of the Object Style used in the master is used as value of this attribute it will be applied. If the objectstyle does not exist, it is NOT created automatically.
RunScript	I			The full file(s) path. 3 parameters are sent to the script. par1 documentname par2 XML iD par3 InDesign GUID
FillTint	I			The percentage of the tint for the background color.
StrokeTint	I			The percentage of the tint for the stroke color.
WMode	I	0 1 2 3 4 5 6 7 8		Wrap mode 0 no text wrap 1 jump object 2 jump to next column 3 wrap around bounding box 4 Invalid, unimplemented 5 Invalid, unimplemented 6 wrap around object shape 7 Invalid, unimplemented 8 Invalid, unimplemented
WOffset	I	top;left;bottom:right;single		Distance of wrap offset Ex: 1;2;1;2;0  Whether the item only supports one value for all sides (that is topMargin is the only valid margin) values 1/0.
WInvert	I	0/1		Invert text wrap.
WSide	I	0 1 2 3 4 5		Wrap side 0 both left & right sides 1 Left side 2 Right side 3 Side Towards Spine 4 Side Away from Spine 5 Largest Area
LCap	I	0 1 2		Line cap 0 But cap 1 Round cap 2 Projecting cap
JType	I	0 1 2		Join type 0 Miter join 1 Round join 2 Bevel join
MLim	I			Miter limit

### Ellipse (Continued)

Attribute	Def <sup>a</sup>	Value(s)	Def. value	Explanation/examples
SAlign	I	0 1 2		Stroke alignment 0 Align stroke to center 1 Align stroke to inside 2 Align stroke to outside
LEnd LStart	I	Simple Bar SquareSolid Square CircleSolid Circle Curved Barbed TriangleWide Triangle SimpleWide		Line end Line start

a.R=Required, I=Implied

## 4.6 Rectangle Element

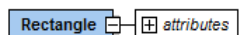

### Rectangle

Attribute	Def <sup>a</sup>	Value(s)	Def. value	Explanation/examples
Width	R			The width of the graphic frame in the specified units.
Height	R			The height of the graphic frame in the specified units.
X	R			The horizontal position of the center point of the graphic frame with reference to the left corner point of the page in the specified units.
Y	R			The vertical position center point of the graphic frame with reference to the left corner point of the page in the specified units.
Stroke	I			The stroke color in swatch or "#rrggbb" or cmyk "c=0;m=100;y=100;k=0;". Value of "None" mean no stroke. If a swatch is used and the swatch does not exist in the master document, it will be created using default color values.
StrokeThickness	I			The thickness of the stroke in points.
StrokeType	I	Solid ThickThick ThickThin ThickThinThick ThinThick ThinThickThin ThinThin Triple_Stroke Canned Dashed 3x2 Canned Dashed 4x4 Left Slant Hash Right Slant Hash Straight Hash Canned Dotted Wavy White Diamond Japanese Dots  Dashed	Solid	Stroke values
Z-Index	R			The z-index of the graphic frame. Can be used to move a frame to the front/back. If the z-index is unknown, use any value like for example 0.
Background	I			Background color in swatch or "#rrggbb" or cmyk "c=0;m=100;y=100;k=0;". Value of "None" mean no stroke. If a swatch is used and the swatch does not exist in the master document, it will be created using default color values.
LayerName	R			The name of the layer where the graphic frame is put on. If the layer does not exist, it is created using defaults
Rotation	I			The rotation of the graphic frame rotated round the centre middle. In degrees.
Opacity	I			The opacity in percentage (values from 0 to 100) of the graphic frame.
Transparency	I			The transparency of the graphic frame (as in Indesign).
Name	I			Only used internally.
CornerRadius	I			The corner effects setting in the specified units of the graphic frame.
CornerType	I	None Rounded Inverse Rounded Inset Bevel Fancy		The corner effect setting of the graphic frame (as in Indesign). Ex: None None None None
Id	I			Only used internally.

## Rectangle (Continued)

Attribute	Def <sup>a</sup>	Value(s)	Def. value	Explanation/examples
Identifier	I			Only used internally.
SitecoreID	R			The SitecoreID attribute is used to identify each page object (Textframe, ImageFrame, etc) with a corresponding Sitecore item. The SitecoreID attribute contains the ID value of that specific item. Each page object item created with the InDesign connector is related to a Sitecore item.  Note: When using a script to create a page object (Textframe, ImageFrame, etc), you should add the SitecoreID attribute and use a default value (e.g. "null") so the InDesign connector can identify this item.
SitecoreFieldname	I			Only used internally.
HorizontalScale	I			Value - / +. Value of 0.8 means scale to 80%. Value of 2 means 200%. HorizontalScale and VerticalScale always need to be set both in order to use scaling.
VerticalScale	I			Value - / +. Value of 0.8 means scale to 80%. Value of 2 means 200%. HorizontalScale and VerticalScale always need to be set both in order to use scaling.
Skew	I			Value in degrees.
ObjectStyle	I			An InDesign Object Style can be used for formatting (effects). When the name of the Object Style used in the master is used as value of this attribute it will be applied. If the objectstyle does not exist, it is NOT created automatically.
RunScript	I			The full file(s) path. 3 parameters are sent to the script. par1 documentname par2 XML iD par3 InDesign GUID
FillTint	I			The percentage of the tint for the background color.
StrokeTint	I			The percentage of the tint for the stroke color.
WMode	I	0 1 2 3 4 5 6 7 8		Wrap mode 0 no text wrap 1 jump object 2 jump to next column 3 wrap around bounding box 4 Invalid, unimplemented 5 Invalid, unimplemented 6 wrap around object shape 7 Invalid, unimplemented 8 Invalid, unimplemented
WOffset	I	top;left;bottom:right;single		Distance of wrap offset Ex: 1;2;1;2;0; Whether the item only supports one value for all sides (that is topMargin is the only valid margin) values 1/0
WInvert	I	0/1		Invert text wrap.
WSide	I	0 1 2 3 4 5		Wrap side 0 both left & right sides 1 Left side 2 Right side 3 Side Towards Spine 4 Side Away from Spine 5 Largest Area
LCap	I	0 1 2		Line cap 0 But cap 1 Round cap 2 Projecting cap
JType	I	0 1 2		Join type 0 Miter join 1 Round join 2 Bevel join
MLim	I			Miter limit

### Rectangle (Continued)

Attribute	Def <sup>a</sup>	Value(s)	Def. value	Explanation/examples
SAlign	I	0 1 2		Stroke alignment 0 Align stroke to center 1 Align stroke to inside 2 Align stroke to outside
LEnd	I	Simple Bar SquareSolid Square CircleSolid Circle Curved Barbed TriangleWide Triangle SimpleWide		(Line end) and LStart (line start)

a.R=Required, I=Implied

## 4.7 Line Element

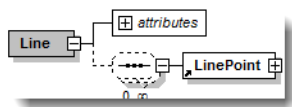

### Line

Attribute	Def <sup>a</sup>	Value(s)	Default Value	Explanation/examples
Width	I			The width of the graphic frame in the specified units. Be aware that initially the line is determined by the LinePoints. The width and height is only used to scale the object once created. When publishing a straight (horizontal) line, the width is not used.
Height	I			The width of the graphic frame in the specified units. Be aware that initially the line is determined by the LinePoints. The width and height is only used to scale the object once created. When publishing a straight (horizontal) line, the width is not used.
X	I			The horizontal position of the center point of the graphic frame with reference to the left corner point of the page in the specified units. Be aware that the line is initially determined by the LinePoints. The X and Y are only used to move the object once it is created.
Y	I			The vertical position center point of the graphic frame with reference to the left corner point of the page in the specified units. Be aware that the line is initially determined by the LinePoints. The X and Y are only used to move the object once it is created.
Background	I			Background color in swatch or "#rrggbb" or cmyk "c=0;m=100;y=100;k=0;". Value of "None" mean no stroke. If a swatch is used and the swatch does not exist in the master document, it will be created using default color values.
Closed	I	True False		True start and end point are joined. False no joining.
CornerRadius	I	N/A		Frame label (not used for now).
CornerType	I	None Rounded Inverse Rounded Inset Bevel Fancy		The corner effects setting in the specified units of the graphic frame. Ex: None None None None
FillTint	I			The percentage of the tint for the background color.
Id	I			Only used internally.
Identifier	I			Only used internally.
JType	I	0 1 2		Join type 0 Miter join 1 Round join 2 Bevel join
LayerName	I			The name of the layer where the graphic frame is put on. If the layer does not exist, it is created using defaults.
LCap	I	0 1 2		Line cap 0 But cap 1 Round cap 2 Projecting cap
LEnd LStart	I	Simple Bar SquareSolid Square CircleSolid Circle Curved Barbed TriangleWide Triangle SimpleWide		(Line end) and LStart (line start)

**Line (Continued)**

Attribute	Def <sup>a</sup>	Value(s)	Default Value	Explanation/examples
MLim	I			Miter limit
Name	I			Only used internally.
ObjectStyle	I			An InDesign Object Style can be used for formatting (effects). When the name of the Object Style used in the master is used as value of this attribute it will be applied. If the objectstyle does not exist, it is NOT created automatically.
Opacity	I			The vertical alignment of the content in the textframe.
Rotation	I			The rotation of the graphic frame rotated round the centre middle. In degrees.
RunScript	I			The full file(s) path. Three parameters are sent to the script. par1 documentname par2 XML iD par3 InDesign GUID
SAlign	I	0 1 2		Stroke alignment 0 Align stroke to center 1 Align stroke to inside 2 Align stroke to outside
SitecoreFieldname	I			Only used internally.
SitecoreID	R			The SitecoreID attribute is used to identify each page object (Textframe, ImageFrame, etc) with a corresponding Sitecore item. The SitecoreID attribute contains the ID value of that specific item. Each page object item created with the InDesign connector is related to a Sitecore item.  Note: When using a script to create a page object (Textframe, ImageFrame, etc), you should add the SitecoreID attribute and use a default value (e.g. "null") so the InDesign connector can identify this item.
Stroke	I			The stroke color in swatch or "#rrggbb" or cmyk "c=0;m=100;y=100;k=0:". Value of "None" mean no stroke. If a swatch is used and the swatch does not exist in the master document, it will be created using default color values.
StrokeThickness	I			The thickness of the stroke in points.
StrokeTint	I			The percentage of the tint for the stroke color.
StrokeType	I	Solid ThickThick ThickThin ThickThinThick ThinThick ThinThickThin ThinThin Triple_Stroke Canned Dashed 3x2 Canned Dashed 4x4 Left Slant Hash Right Slant Hash Straight Hash Canned Dotted Wavy White Diamond Japanese Dots  Dashed	Solid	Stroke values
Transparency	I	0-100		Real Numbers The opacity in percentage of the graphic frame.
WInvert	I	0 1		Invert text wrap
WMode	I	0 1 2 3 4 5 6 7 8		0 (no text wrap) 1 (jump object) 2 (jump to next column) 3 (wrap around bounding box) 4 Invalid, unimplemented 5 Invalid, unimplemented 6 (wrap around object shape) 7 Invalid, unimplemented 8 Invalid, unimplemented



### Line (Continued)

Attribute	Def <sup>a</sup>	Value(s)	Default Value	Explanation/examples
WOffset	I	top left bottom right single		Distance of wrap offset Ex: 1;2;1;2;0;
WSide	I	0 1 2 3 4 5		Wrap side 0 Both left & right sides 1 Left side 2 Right side 3 Side Towards Spine 4 Side Away from Spine 5 Largest Area
Z-Index	I			The z-index of the graphic frame. Can be used to move a frame to the front/back. If the z-index is unknown, use any value like for example 0.

a.R=Required, I=Implied

## 4.7.1 LinePoint Element

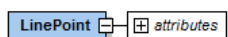

### LinePoint

Attribute	Def <sup>a</sup>	Value(s)	Default Value	Explanation/examples
AnchorPointX	I			The horizontal position of the anchor point in the specified units.
AnchorPointY	I			The vertical position of the anchor point in the specified units.
LeftDirPointX	R			The horizontal position of the Left-direction point in the specified units.
LeftDirPointY	R			The vertical position of the Left-direction point in the specified units.
PointType	R	kL kCS kCK		kL Line point kCS Continuous smooth point kCK Continuous unsmooth point
RightDirPointX	I			The horizontal position of the Right-direction point in the specified units.
RightDirPointY	I			The vertical position of the Right-direction point in the specified units.

a.R=Required, I=Implied

## Chapter 5

# Content Elements

This chapter describes the content elements that can be used within a text frame, table cell or Inline frame.

This chapter contains the following sections:

- ParagraphStyle Element
- CharacterStyle Element
- SpecialCharacter Element
- InsertVar Element

## 5.1 ParagraphStyle Element

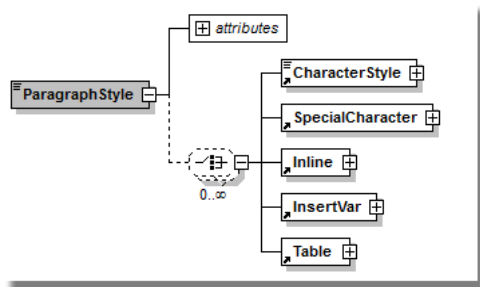

### ParagraphStyle

Attribute	Def <sup>a</sup>	Value(s)	Default Value	Explanation/examples
Style	R			The style name that needs to be used to format this paragraph.

a.R=Required, I=Implied

## 5.2 CharacterStyle Element

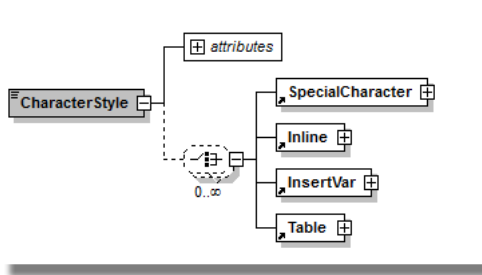

### CharacterStyle

Attribute	Def <sup>a</sup>	Value(s)	Default Value	Explanation/examples
Style	R			The style name that needs to be used to format this set of characters.

a.R=Required, I=Implied

### 5.3 SpecialCharacter Element

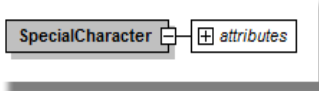

#### SpecialCharacter

Attribute	Def <sup>a</sup>	Value(s)	Default Value	Explanation/examples
Type	R	3 7 8 9 10 24 25 160 173 8212 8211 8209 8193 8194 8195 8199 8200 8201 8202 1396927554		3 End nested style 7 Indent to here 8 Right aligned tab 9 Tab 10 Hard return (new paragraph) 24 Page numbers 25 Section marker 160 Nonbreaking space 173 Discretionary hyphen 8212 Em dash 8211 En dash 8209 Nonbreaking Hyphen 8193 Flush space 8194 En space 8195 Em space 8199 Figure space 8200 Punctuation space 8201 Thin space 8202 Hair space 1396927554 Column break

a.R=Required, I=Implied

## 5.4 InsertVar Element

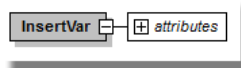

### InsertVar

Attribute	Def <sup>a</sup>	Value(s)	Def. value	Explanation/examples
Name				Name of the variable. If the variable does not exist in the master, a new variable of the type "Custom Text" is created. If the variable exists (regardless of type) it is inserted in the content at the place where the InsertVar element is placed.
Value				Value of the variable (content). The value will only be set if the variable is of the type "Custom Text".

a.R=Required, I=Implied

### 5.4.1 Using the InsertVar Element in a Table of Contents

Besides using the InsertVar element to insert variables in the content, you can also use the InsertVar element to generate a table of contents and/or index. To generate a table of contents, you need to publish the InsertVar element in the content and publish a corresponding InsertVar element in the table of contents. The source element will be used to determine the page number. The page number will be published at the location of the target variable.

In the content:

```
<InsertVar Name="TTOC_1" Value="" />
```

In the table of contents:

```
<InsertVar Name="TOC_1" Value="" />
```

Make sure the name of the source variable uses the prefix "TTOC\_" and the target variable uses the prefix "TOC\_". You can add any other value, for example "TTOC\_DOC\_1".

An example of a basic XML:

```

1 <?xml version="1.0" encoding="UTF-8" standalone="yes"?>
2 <Project Units="points" CloseProject="True">
3 <Books>
4 <Book BookFilename="" ExportPDF="False" PrintBook="False">
5 <Documents>
6 <Document Type="Dynamic" MasterFilename="" DocFilename="c:\temptests\TOC_test.indd" PageWidth="612.0000000000000000" PageHei
7 <Preferences SuperScriptPos="33.299999999999997" SuperScriptSize="58.299999999999997" SubScriptPos="33.299999999999997" Su
8 <Colors>
94 <Styles>
125 <Layers>
133 <Pages>
134 <Page MasterPrefix="A" MasterBase="Master" Number="1">
135 <TextFrame Width="100" Height="100" X="80" Y="80" Z-Index="11">
136 <ParagraphStyle Style="P_ProductGroup">table of contents</ParagraphStyle>
137 <ParagraphStyle Style="Body">Title 1<SpecialCharacter Type="9"/><InsertVar Name="TOC_1" Value=""/></ParagraphStyle>
138 <ParagraphStyle Style="Body">Title 2<SpecialCharacter Type="9"/><InsertVar Name="TOC_2" Value=""/></ParagraphStyle>
139 </TextFrame>
140 </Page>
141 <Page MasterPrefix="A" MasterBase="Master" Number="2">
142 <TextFrame Width="150" Height="150" X="150" Y="150" Z-Index="11">
143 <ParagraphStyle Style="P_ProductGroup">source contents
144 </ParagraphStyle>
145 <ParagraphStyle Style="Body">This is the source title 1<InsertVar Name="TTOC_1" Value=""/></ParagraphStyle>
146 <ParagraphStyle Style="Body">This is the source title 2<InsertVar Name="TTOC_2" Value=""/></ParagraphStyle>
147 </TextFrame>
148 </Page>
149 </Pages>
150 </Document>
151 </Documents>
152 </Book>
153 </Books>
154 </Project>
155
    
```

This would generate a document with the first page:

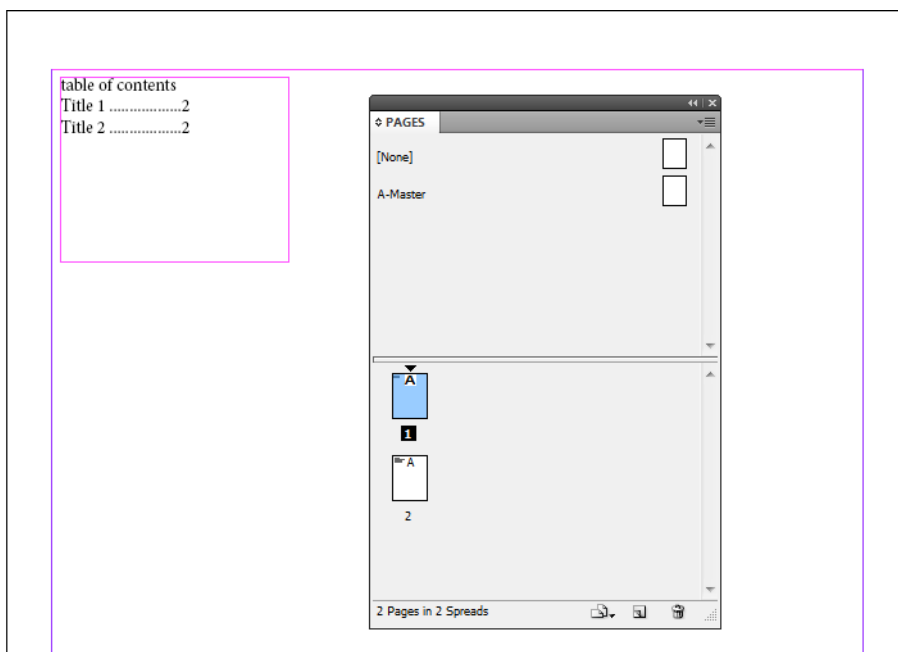

The second page (with the source content):

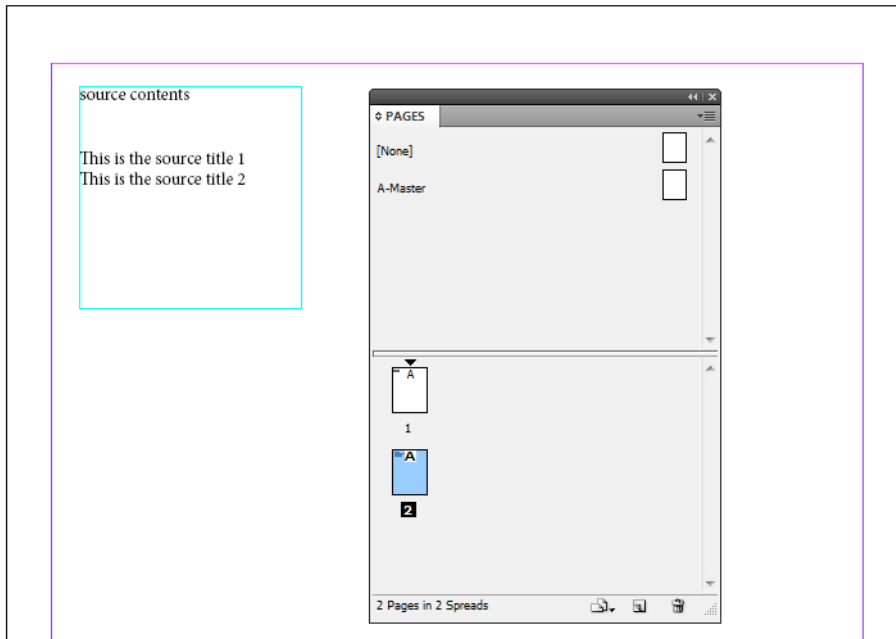

If you work with several documents in a book, you can use the same steps to publish a separate table of contents document inside the book.



A sample XML could look like:

```

4      <Book CreateBook="True" BookFilename="c:\temp\tests\TOCBook.indb" ExportPDF="False" PrintBook="False">
5      <Documents>
6      <Document Type="Dynamic" MasterFilename="c:\temp\tests\TOCmaster.indd" DocFilename="c:\temp\tests\TOC_test.indd" PageWidth="61;
7      <Preferences SuperScriptPos="33.299999999999997" SuperScriptSize="58.299999999999997" SubScriptPos="33.299999999999997" Sut
8      <Colors>
94     <Styles>
125    <Layers>
133    <Pages>
134    <Page MasterPrefix="A" MasterBase="Master" Number="1">
135    <TextFrame Width="100" Height="100" X="80" Y="80" Z-Index="11">
136    <ParagraphStyle Style="P_ProductGroup">table of contents</ParagraphStyle>
137    <ParagraphStyle Style="Body">Title 1<SpecialCharacter Type="9"/><InsertVar Name="TOC_1" Value=""/></ParagraphStyle>
138    <ParagraphStyle Style="Body">Title 2<SpecialCharacter Type="9"/><InsertVar Name="TOC_2" Value=""/></ParagraphStyle>
139    <ParagraphStyle Style="Body">Title 2<SpecialCharacter Type="9"/><InsertVar Name="TOC_3" Value=""/></ParagraphStyle>
140    <ParagraphStyle Style="Body">Title 2<SpecialCharacter Type="9"/><InsertVar Name="TOC_4" Value=""/></ParagraphStyle>
141    </TextFrame>
142    </Page>
143  </Pages>
144  </Document>
145  <Document Type="Dynamic" MasterFilename="c:\temp\tests\TOCmaster.indd" DocFilename="c:\temp\tests\TOC_content_test.indd" PageW
146  <Preferences SuperScriptPos="33.299999999999997" SuperScriptSize="58.299999999999997" SubScriptPos="33.299999999999997" Sut
147  <Colors>
233  <Styles>
264  <Layers>
272  <Pages>
273  <Page MasterPrefix="A" MasterBase="Master" Number="5">
274  <TextFrame Width="150" Height="150" X="150" Y="150" Z-Index="11">
275  <ParagraphStyle Style="P_ProductGroup">source contents
276  </ParagraphStyle>
277  <ParagraphStyle Style="Body">This is the source title 1<InsertVar Name="TTOC_1" Value=""/></ParagraphStyle>
278  <ParagraphStyle Style="Body">This is the source title 2<InsertVar Name="TTOC_2" Value=""/></ParagraphStyle>
279  </TextFrame>
280  </Page>
281  <Page MasterPrefix="A" MasterBase="Master" Number="">
282  <TextFrame Width="150" Height="150" X="150" Y="150" Z-Index="11">
283  <ParagraphStyle Style="P_ProductGroup">source contents
284  </ParagraphStyle>
285  <ParagraphStyle Style="Body">This is the source title 3<InsertVar Name="TTOC_3" Value=""/></ParagraphStyle>
286  <ParagraphStyle Style="Body">This is the source title 4<InsertVar Name="TTOC_4" Value=""/></ParagraphStyle>
287  </TextFrame>
288  </Page>
289  </Pages>
290  </Document>
291  </Documents>
292  </Book>

```

### Note

Please note that the start number of the first page in the second document is set to 5 since we (for this example) want the first document to start on page number 5.

To set the numbering options:

1. Select the first page in the master document.
2. Right-click and select **Numbering & Section Options**:

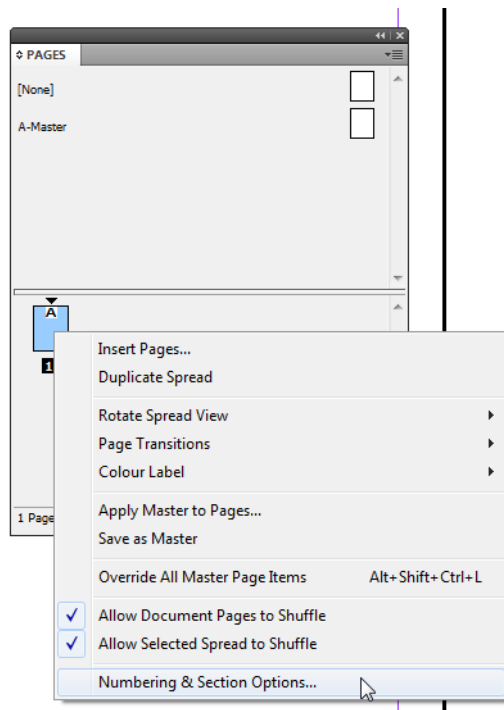

The “Numbering & Section Options” dialog is displayed:

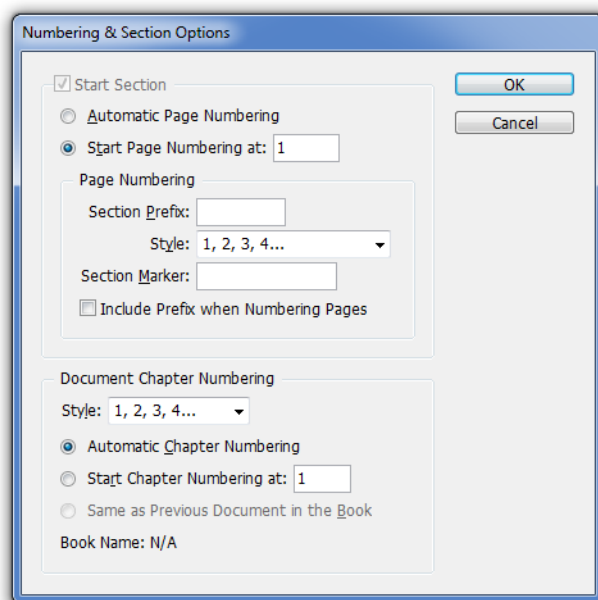

3. Select **Start Page Numbering at:** and set the value to 1. When the document is generated the start number will be set from the XML and in this case 1 will be set to 5.

This would produce a book file and two documents. This would look like:

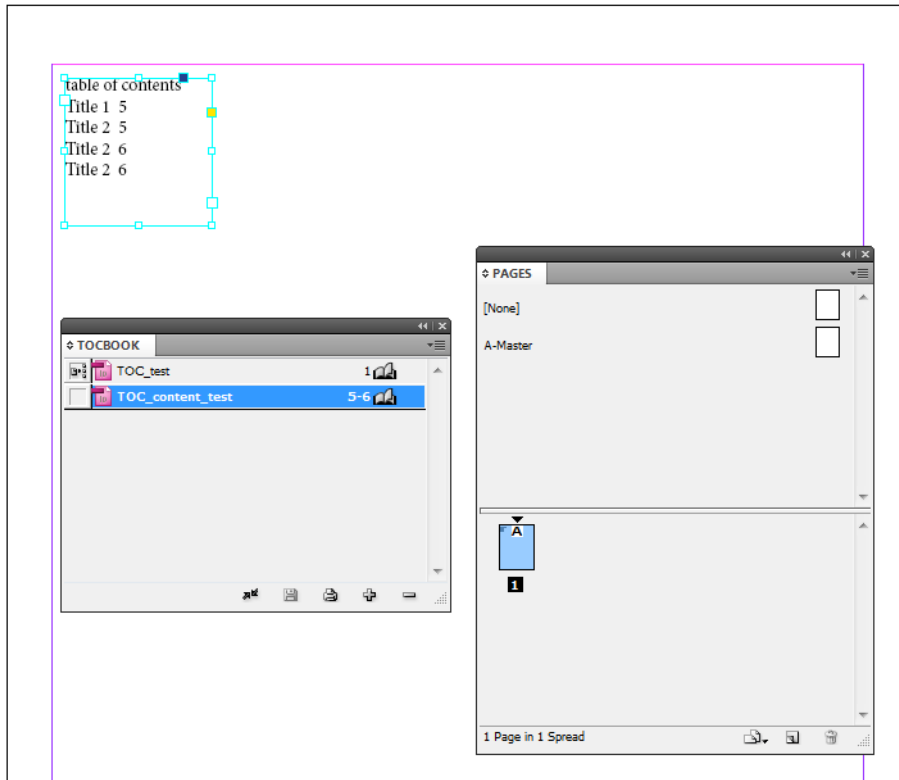

and:

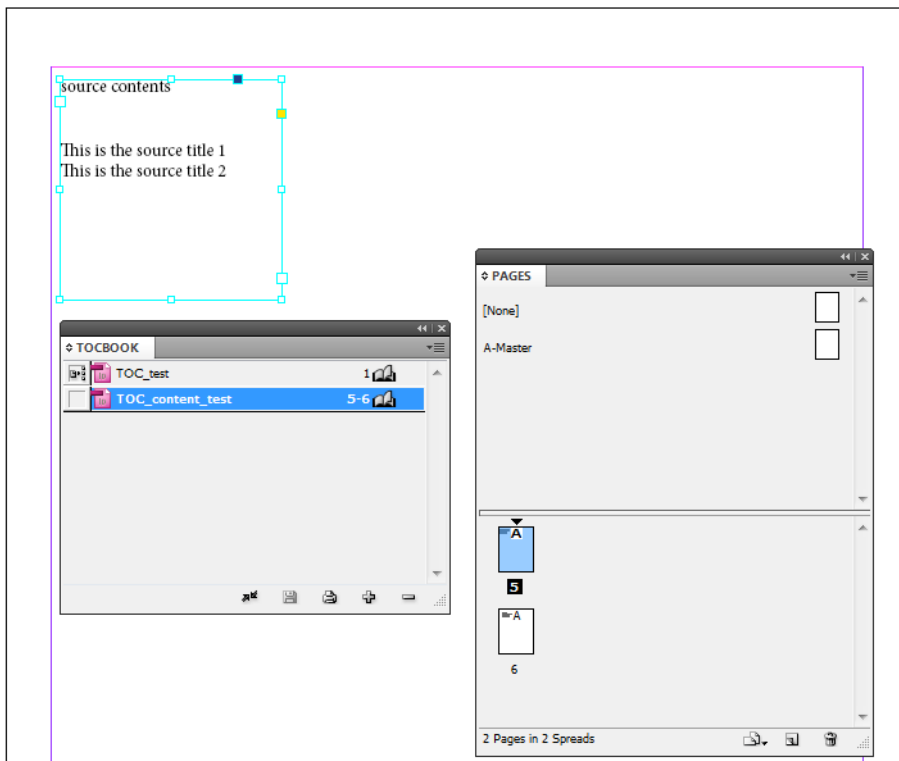

**Note**

Documents with facing Pages selected (left and right pages face each other in a double-page spread) that start with an even page number (Number attribute) begin on the left page. Odd-numbered pages are right-hand pages.

## 5.4.2 Using the InsertVar Element in an Index

To generate an index, you need to publish the InsertVar element in the content and you need to publish a corresponding InsertVar element in the index as well. The source element will then be used to determine the page number and the page number will be published at the location of the target variable.

In the content:

```
<InsertVar Name="TI_1" Value=""/>
```

In the index:

```
<InsertVar Name="I_1" Value=""/>
```

The index helps you to find information in long documents. Therefore you need several places in the content where variables correspond with an index variable.

A sample XML could look like:

```

1  <?xml version="1.0" encoding="UTF-8" standalone="yes"?>
2  <Project Units="mm">
3  <Books>
4  <Book CreateBook="True" BookFilename="c:\temp\tests\INXBook.indb" ExportPDF="False" PrintBook="False">
5  <Documents>
6  <Document Type="Dynamic" MasterFilename="c:\temp\tests\INXmaster.indd" DocFilename="c:\temp\tests\INX_content_test.indd" PageWid
7  <Pages>
8  <Page MasterPrefix="A" MasterBase="Master" Number="1">
9  <TextFrame Width="150" Height="150" X="150" Y="150" Z-Index="11">
10 <ParagraphStyle Style="P_ProductGroup">source contents
11 </ParagraphStyle>
12 <ParagraphStyle Style="Body">This is the source item 1<InsertVar Name="TI_0" Value=""/>
13 </ParagraphStyle>
14 <ParagraphStyle Style="Body">This is the source item 2<InsertVar Name="TI_1" Value=""/>
15 </ParagraphStyle>
16 </TextFrame>
17 </Page>
18 <Page MasterPrefix="A" MasterBase="Master" Number="">
19 <TextFrame Width="150" Height="150" X="150" Y="150" Z-Index="11">
20 <ParagraphStyle Style="P_ProductGroup">source contents
21 </ParagraphStyle>
22 <ParagraphStyle Style="Body">This is the source item 1<InsertVar Name="TI_0" Value=""/>
23 </ParagraphStyle>
24 <ParagraphStyle Style="Body">This is the source item 2<InsertVar Name="TI_2" Value=""/>
25 </ParagraphStyle>
26 </TextFrame>
27 </Page>
28 </Pages>
29 </Document>
30 <Document Type="Dynamic" MasterFilename="c:\temp\tests\INXmaster.indd" DocFilename="c:\temp\tests\INX_test.indd" PageWidth="612.1
31 <Pages>
32 <Page MasterPrefix="A" MasterBase="Master" Number="3">
33 <TextFrame Width="100" Height="100" X="80" Y="80" Z-Index="11">
34 <ParagraphStyle Style="P_ProductGroup">Index</ParagraphStyle>
35 <ParagraphStyle Style="Body">Item 1<SpecialCharacter Type="9"/>
36 <InsertVar Name="I_0" Value=""/>
37 </ParagraphStyle>
38 <ParagraphStyle Style="Body">Item 2<SpecialCharacter Type="9"/>
39 <InsertVar Name="I_1" Value=""/>
40 </ParagraphStyle>
41 </TextFrame>
42 </Page>
43 </Pages>
44 </Document>
45 </Documents>
46 </Book>
47 </Books>
    
```

In InDesign this would look like:

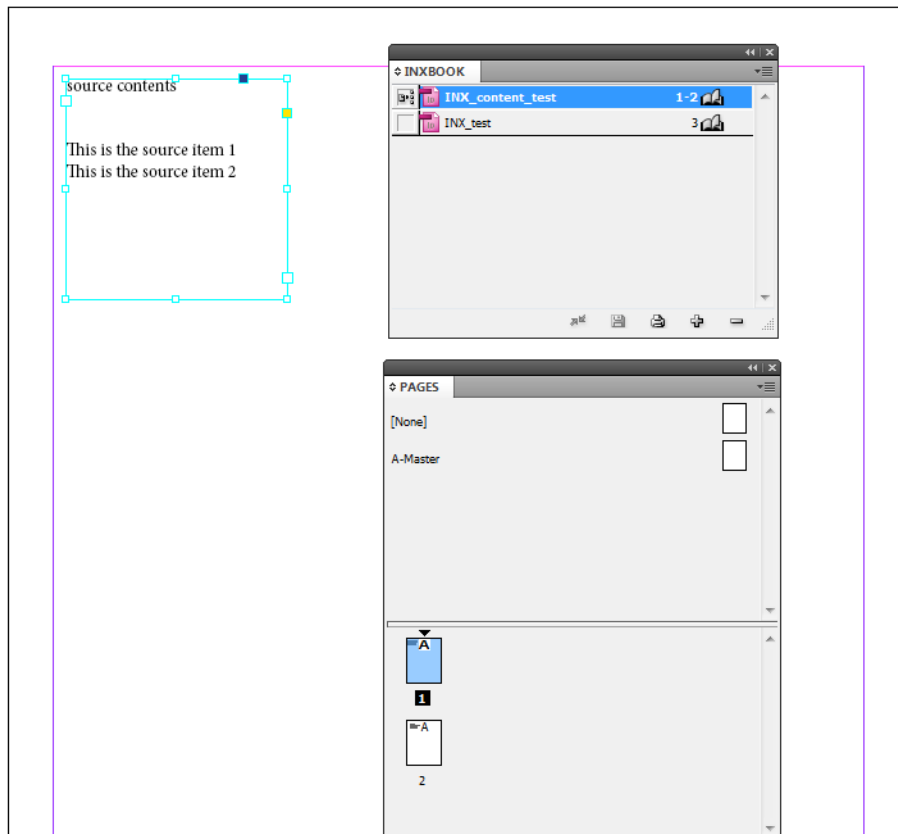

And in the index document:

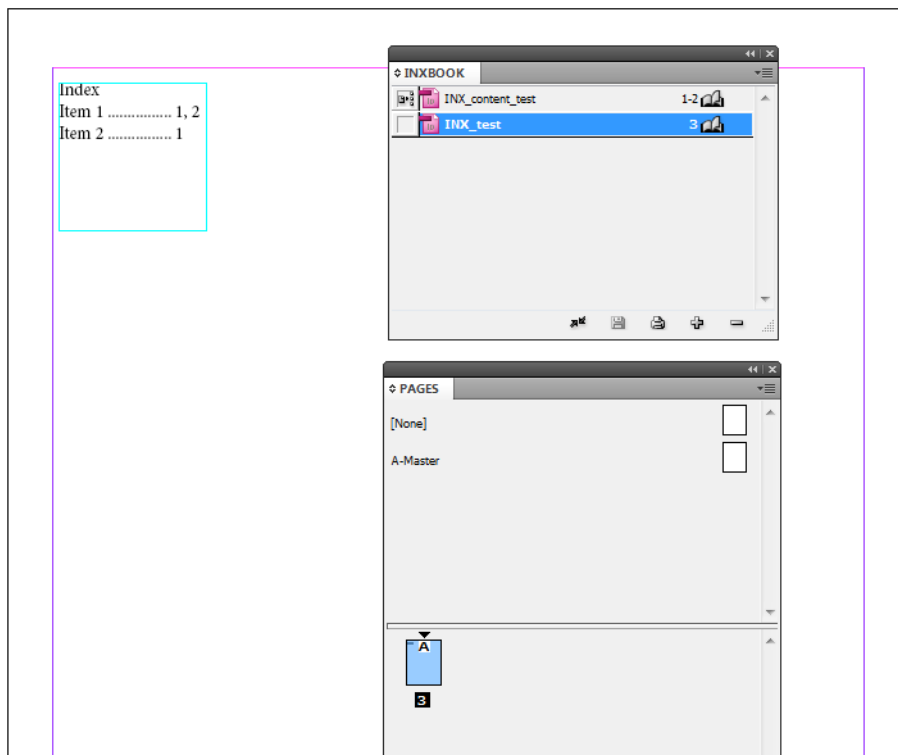

## Chapter 6

### Tables

This chapter describes the elements involved with creating InDesign tables.

This chapter contains the following sections:

- Table Element
- Row Element
- Cell Element

## 6.1 Table Element

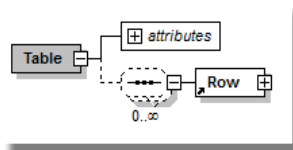

### Table

Attribute	Def <sup>a</sup>	Value(s)	Def. value	Explanation/examples
TableStyle	I		0	The name of the table style to use for this table. If the style is not available in the master, the table style is created using defaults.
ColCount	I			The number of columns. The default value is taken from the structure (number of cells in first row). If ColCount $\leq 0$ then the table is not created. If ColCount value is less than the number of cells in the structure, then the number of cells out of structure taken over.  <b>Be aware:</b> The number of columns always needs to be larger than 0 and can't be left empty. The number of columns also needs to correspond with the amount of cell elements for each row in the XML.
HeaderRows	I		0	The number of header rows. The RowCount includes the number of header rows. So for a table with 1 header row and 9 body rows the rowcount is 10.
FooterRows	I		0	The number of footer rows. The RowCount includes the number of header rows. For a table with 1 header row, 1 footer row and 8 body rows the rowcount is 9.
RowCount	I			The number of rows. If left empty, the number of rows is determined based on the XML structure of the table.  The default value is taken from the structure (the number of rows of the table). If RowCount $\leq 0$ then the table is not created. If RowCount value is less than the number of rows in the structure, the value taken over structure.
RepeatHeader	I	OncePerPage OncePerFrame EveryTextColumn	OncePerFrame	Sets the way the table header is repeated.
RepeatFooter	I	OncePerPage OncePerFrame EveryTextColumn	OncePerFrame	Sets the way the table footer is repeated.

a.R=Required, I=Implied



## 6.2 Row Element

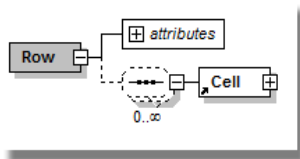

### Row

Attribute	Def <sup>a</sup>	Value(s)	Def. value	Explanation/examples
RowHeight	I	AtLeast Exactly)	AtLeast	Sets the way the row height needs to be set.
RowMin	I		2	The value is the minimum height of a row.
RowMax	I		200	The value is the maximum height of a row.
StartRow	I	Anywhere NextColumn NextFrame NextPage NextOddPage NextEvenPage	Anywhere	Sets the way this row needs to be positioned.
KeepWithNext	I	True False	False	Set to True if the row needs to remain together with the row above.

a.R=Required, I=Implied

### 6.3 Cell Element

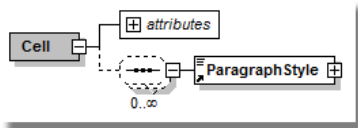

#### Cell

Attribute	Def <sup>a</sup>	Value(s)	Def. value	Explanation/examples
CellStyle	R			The name of the cell style. If the cell style does not exist in the master document, it is created using defaults.
ColWidth	R			The width of the column.
HorStradle	R			Value is horizontal stradle (stradle of columns: no stradle value is "0" when no value is inserted "0" is used default. Two columns stradle value is "1")
VerStradle	R			Value is vertical stradle (stradle of rows: no stradle value is "0" when no value is inserted "0" is used default. Two rows stradle value is "1")

a.R=Required, I=Implied

The following example shows how to use the HorStradle attribute to merge the first three cells of the first row.

```

1  <?xml version="1.0" encoding="UTF-8"?>
2  <!DOCTYPE Table SYSTEM "D:\SourceCode\engine schema\PrintStu
3  <Table ColCount="" HeaderRows="" FooterRows="" TableStyle="">
4  <Row>
5      <Cell CellStyle="" ColWidth="" HorStradle="2" VerStradle="">
6      <Cell CellStyle="" ColWidth="" HorStradle="0" VerStradle="">
7      <Cell CellStyle="" ColWidth="" HorStradle="0" VerStradle="">
8      <Cell CellStyle="" ColWidth="" HorStradle="0" VerStradle="">
9  </Row>
10 <Row>
11 <Cell CellStyle="" ColWidth="" HorStradle="0" VerStradle="">
12 <Cell CellStyle="" ColWidth="" HorStradle="0" VerStradle="">
13 <Cell CellStyle="" ColWidth="" HorStradle="0" VerStradle="">
14 <Cell CellStyle="" ColWidth="" HorStradle="0" VerStradle="">
15 </Row>
16 </Table>
17
    
```

This will create the following table in InDesign:

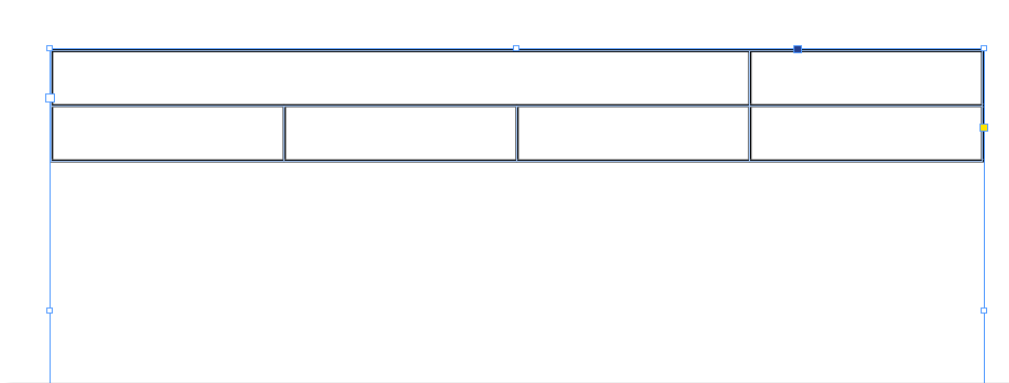

Be aware to use straddles correctly. If you create a row with four cells and stradle the first cell with the other three cells, this is basically a row with one cell.

## Chapter 7

### Inline Frames

This chapter describes the elements involved with creating Inline frames.

This chapter contains the following sections:

- Inline Element

## 7.1 Inline Element

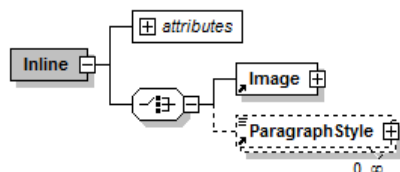

### Inline

Attribute	Def <sup>a</sup>	Value(s)	Default Value	Explanation/examples
Type	R	Text Graphic Ellipse Rectangle Path	Text	Text Text frame Graphic Graphic frame Ellipse Ellipse Rectangle Rectangle Path Path.
ParagraphStyle	I			Then type text is used the paragraph style to format the content can be set here.
Height	R			The height of the graphic frame in the specified units.
Width	R			The width of the graphic frame in the specified units.
Position	R	Inline Aboveline	Inline	The position of the frame.
YOffset	I			Offset from baseline (for inline max. line height).
XOffset	I			Offset from
Alignment	I	Left Right Center TowardsSpine AwayFromSpine TextAlignment	Left	The inline frame alignment.
SpaceBefore	I			The space before an inline frame.
PreventManualPositioning	I	Yes No	No	Yes means inline frames are locked and can not be changed manually No means inline frames can be changed manually.
RelativeToSpine	I	Yes No	No	The inline frame can be positioned relative to layout properties.
AnchObjPtHor	I	Left Center Right	Left	The inline frame(Obj) can be anchored relative to horizontal layout properties.
AnchObjPtVer	I	Top Center Bottom	Top	The inline frame(Obj) can be anchored relative to vertical layout properties.
AnchPosPtHor	I	Left Center Right	Left	The inline frame(Pos) can be relative to horizontal layout properties.
AnchPosPtVer	I	Top Center Bottom	Top	The inline frame(Pos) can be relative to vertical layout properties.
XRelativeTo	I	AnchorMarker ColumnEdge TextFrame PageMargin PageEdge	TextFrame	The inline frame can be positioned relative to the X value.

**Inline (Continued)**

Attribute	Def <sup>a</sup>	Value(s)	Default Value	Explanation/examples
YRelativeTo	I	Baseline LineCapHeight LineTopLeading ColumnEdge TextFrame PageMargin PageEdge	Baseline	The inline frame can be positioned relative to the Y value.
BottomTopBoundries	I	Yes No	Yes	Yes means inline frames are placed within the flow boundaries. No means inline frames are placed within and without the flow boundaries.
Opacity	I	0-100		Integer The opacity in percentage of the graphic frame.
Transparency	I			The transparency of the graphic frame (as in Indesign).
CornerRadius	I			The corner effects setting in the specified units of the graphic frame.
CornerType	I			The corner effect setting of the graphic frame (as in Indesign).
Name	I			Frame label (not used for now).
Stroke	I			The stroke color in swatch or #rrggb or cmyk. c=0;m=100;y=100;k=0;
StrokeThickness	I			The thickness of the stroke in points.
StrokeType	I	Solid ThickThick ThickThin ThickThinThick ThinThick ThinThickThin ThinThin Triple_Stroke Canned Dashed 3x2 Canned Dashed 4x4 Left Slant Hash Right Slant Hash Straight Hash Canned Dotted Wavy White Diamond Japanese Dots  Dashed).	Solid	The type of stroke values.
Rotation	I			The rotation of the graphic frame rotated round the centre middle. In degrees.
Background	I			Background color in swatch or #rrggb or cmyk c=0;m=100;y=100;k=0;
margin-left	I			Left margin in the specified units.
margin-top	I			Top margin in the specified units.
margin-right	I			Right margin in the specified units.
margin-bottom	I			Bottom margin in the specified units.
VerticalAlignment	I	Top Middle Bottom Justify	Top	The vertical alignment of the content in the frame when "Type" text is used.
Id	I			The automatic generated identifier for this object.
Identifier	I			Can be used to specify an identifier for this object.
SitecoreID	I			Only used in combination with Sitecore. Identifies Sitecore items created from InDesign objects.
SitecoreFieldname	I			Only used in combination with Sitecore. Identifies Sitecore item fields used for creating InDesign objects.

**Inline (Continued)**

Attribute	Def <sup>a</sup>	Value(s)	Default Value	Explanation/examples
Scaling	I	Fit Content to Frame Fit Frame to Content Center Content Fit Content Proportionally Fill Frame Proportionally Fit Content Proportionally and Center		Images can be scaled automatically.
HorizontalScale	I			Value - / +
VerticalScale	I			Value - / +
Skew	I			Value in degrees.
Center	I	True False	False	False do nothing True the image is placed as Indesign value "Center Content", attribute is used with scaling attributes (values).
FitFrame	I	True False	False	False do nothing True the frame is placed as Indesign value "Fit frame to Content", attribute is used with scaling attributes (values).  When textual content, fit frame to content will only work when the number of columns is 1.
ObjectStyle	I			An InDesign Object Style can be used for formatting (effects). If the name of the Object Style used in the master is used as value of this attribute it will be applied.
FillTint	I			The percentage of the tint for the background color.
StrokeTint	I			The percentage of the tint for the stroke color.
WMode	I	0 1 2 3 4 5 6 7 8		Wrap mode 0 no text wrap 1 jump object 2 jump to next column 3 wrap around bounding box 4 Invalid, unimplemented 5 Invalid, unimplemented 6 wrap around object shape 7 Invalid, unimplemented 8 Invalid, unimplemented
WOffset	I	top;left;bottom;right;single		Distance of wrap offset Ex: 1;2;1;2;0; Whether the item only supports one value for all sides (that is topMargin is the only valid margin) values 1/0.
WInvert	I	0 1		Invert text wrap.
WSide	I	0 1 2 3 4 5		Wrap side 0 both left & right sides 1 Left side 2 Right side 3 Side Towards Spine 4 Side Away from Spine 5 Largest Area)
WIgnore	I	1 0		Ignore textwrap (only for text frames) 1 Ignore textwrap
LCap	I	0 1 2		Line cap 0 But cap 1 Round cap 2 Projecting cap
JType	I	0 1 2		Join type 0 Miter join 1 Round join 2 Bevel join
MLim	I			Miter limit

**Inline (Continued)**

Attribute	Def <sup>a</sup>	Value(s)	Default Value	Explanation/examples
SAlign	I	0 1 2		Stroke alignment 0 Align stroke to center 1 Align stroke to inside 2 Align stroke to outside
LEnd	I	Simple Bar SquareSolid Square CircleSolid Circle Curved Barbed TriangleWide Triangle SimpleWide		(Line end) and LStart (line start)
BalCols	I	True/False		Balance columns

a.R=Required, I=Implied



## Chapter 8

### Flow Elements

Although most InDesign productions are page-oriented, the Engine also allows to produce more data driven productions. In this case pages are added if more space is needed to flow the content.

This chapter contains the following sections:

- Flow Element
- Footnote Element

## 8.1 Flow Element

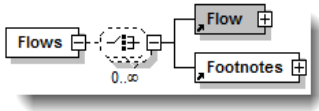

### Flow

Attribute	Def <sup>a</sup>	Value(s)	Def. value	Explanation/examples
MasterPrefix				For InDesign for example "A", "B" and so on.
MasterBase				For InDesign for example "Master".
Number				The number used to identify the page. If a page exists, the page objects are added to that specific page. If the pages in the document are less than the number specified, the page is not shown in the PDF. The pages after the flow within the same document have to be auto numbered (left with no Number value).

a.R=Required, I=Implied

When using a Flow type production, pages are automatically added when necessary. The content is placed automatically using a globally defined text frame. These text frames are fetched from the master page referred to by using the MasterPrefix and MasterBase attributes of the Flow element. Make sure your master pages contain these text frames and are placed in a layer called "flow". See the following example:

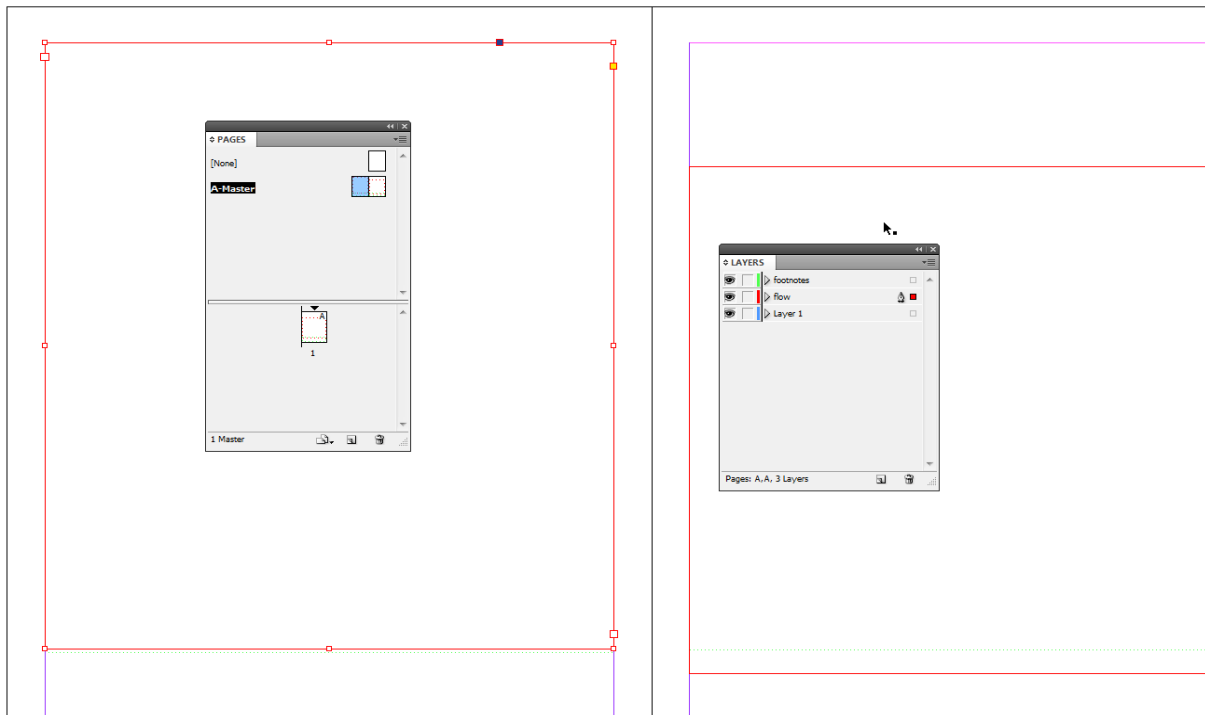

The very basic structure of a flow type production looks like:

```

1  <?xml version="1.0" encoding="UTF-8" standalone="yes"?>
2  <Project>
3  <Books>
4  <Book BookFilename="" ExportPDF="False" PrintBook="False">
5  <Documents>
6  <Document Type="Dynamic" MasterFilename="C:\temp\simpleDocMaster.indd" DocFilename="C:\temp\simpleDoc.indd">
7  <Pages>
8  <Flow MasterPrefix="A" MasterBase="Master">
9  <ParagraphStyle Style="BodyText">Some content</ParagraphStyle>
10 </Flow>
11 </Pages>
12 </Document>
13 </Documents>
14 </Book>
15 </Books>
16 </Project>
17

```

Or when combined with a page type production:

```

1  <?xml version="1.0" encoding="UTF-8" standalone="yes"?>
2  <Project>
3  <Books>
4  <Book BookFilename="" ExportPDF="False" PrintBook="False">
5  <Documents>
6  <Document Type="Dynamic" MasterFilename="C:\temp\simpleDocMaster.indd" DocFilename="C:\temp\simpleDoc.indd">
7  <Pages>
8  <Page MasterPrefix="A" MasterBase="Master" Number="1">
9  <Rectangle X="50" Y="50" Width="100" Height="100" Z-Index="1"/>
10 </Page>
11 <Page MasterPrefix="A" MasterBase="Master" Number="">
12 <Rectangle X="50" Y="50" Width="100" Height="100" Z-Index="1"/>
13 </Page>
14 <Flow MasterPrefix="A" MasterBase="Master">
15 <ParagraphStyle Style="BodyText">Some content</ParagraphStyle>
16 </Flow>
17 </Pages>
18 </Document>
19 </Documents>
20 </Book>
21 </Books>
22

```

## 8.2 Footnote Element

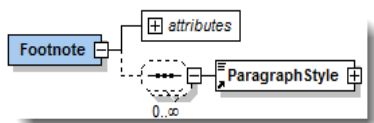

### Footnote

Attribute	Def <sup>a</sup>	Value(s)	Def. value	Explanation/examples
Name	R			The name of the footnote used for matching, there must be an <code>&lt;InsertVar Name=""/&gt;</code> with the same name.
AutoNumber	R	True False	True	True the footnote will be numbered automatically according to selected value of the attribute type.
Type	R	Numbers Alphabetical	Numbers	The selected type of numbering.
Prefix	R			The characters set before the Number or Letter (alphabetical) for example Nr_ or Fn_
Suffix	R			The characters set after the Number or Letter (alphabetical) for example 1 _Fn
Style	R		NoCharacterS tyle	The style (character style) used for formatting the AutoNumber. The paragraph style set for the Footnote (and AutoNumber) is the style of the first paragraph style of Footnote.

a.R=Required, I=Implied

The footnotes are defined in a general section (child of flows). Each footnote can be referenced in the content by inserting a variable (InsertVar element) that has a name that corresponds with the name of the footnote. The Engine will collect and publish all the referenced footnotes on the specific page.

The footnotes will be published inside a text frame that is globally defined on the master pages that are referenced for the flow. Make sure the master page has a text frame on a layer called “flow” as you can see in the following screenshot.

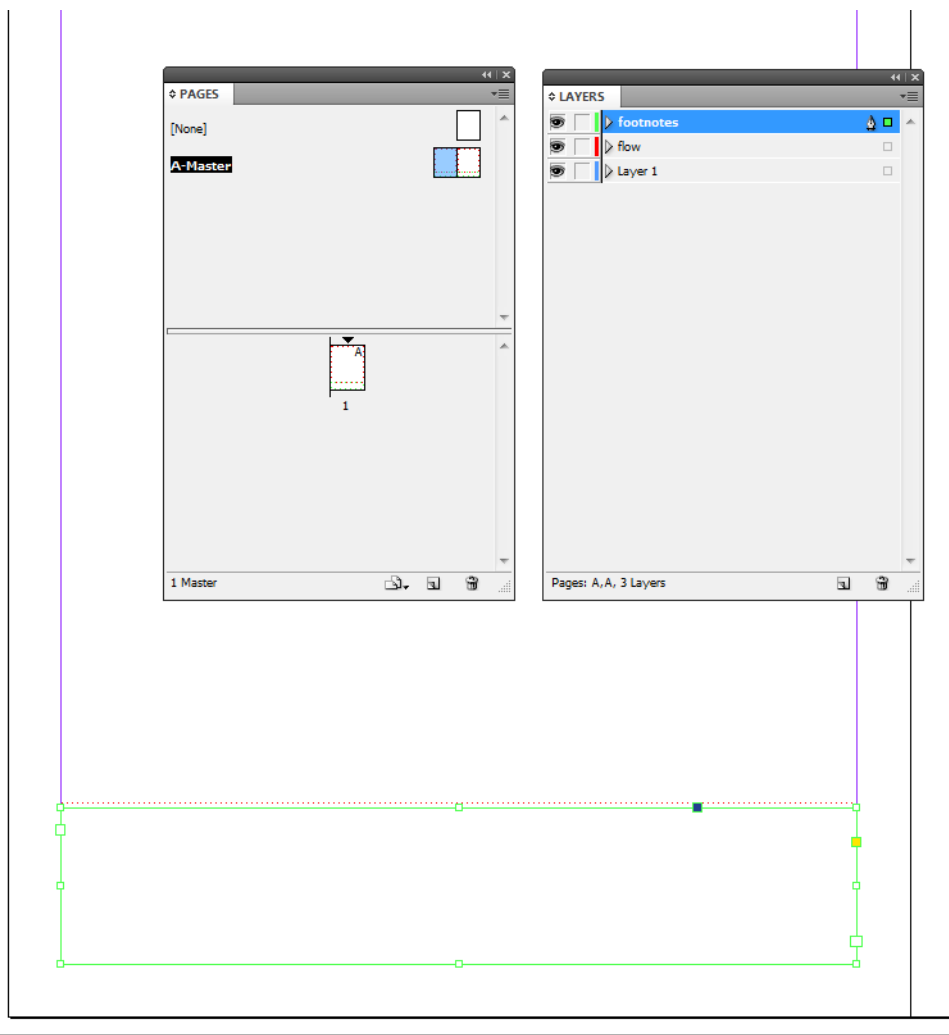

The basic XML structure looks like:

```

.xml version="1.0" encoding="UTF-8" standalone="yes"?>
  <Project Units="points" CloseProject="True">
    <Books>
      <Book BookFilename="" ExportPDF="False" PrintBook="False">
        <Documents>
          <Document Type="Dynamic" MasterFilename="C:\temp\tests\footnotemaster.indd" DocFilename="C:\temp\tests\output_test.indd" PageWidth="612.00000000000000" PageHeight="792.00000000000000">
            <Flows>
              <Footnotes>
                <Footnote Name="FN_1" Autonumber="False" Type="Numbers" Style="Super" Prefix="Nr." Suffix="...">
                  <ParagraphStyle Style="NormalParagraphStyle"><![CDATA[footnote 1]]</ParagraphStyle>
                </Footnote>
                <Footnote Name="FN_2" Autonumber="True" Type="Numbers" Style="Super" Prefix="Nr." Suffix="...">
                  <ParagraphStyle Style="NormalParagraphStyle"><![CDATA[footnote 2]]</ParagraphStyle>
                </Footnote>
                <Footnote Name="FN_3" Autonumber="True" Type="Alphabetical" Style="Super" Prefix="Nr." Suffix="...">
                  <ParagraphStyle Style="NormalParagraphStyle"><![CDATA[footnote 3]]</ParagraphStyle>
                </Footnote>
              </Footnotes>
              <Flow MasterPrefix="A" MasterBase="Master">
                <ParagraphStyle Style="NormalParagraphStyle"><![CDATA[Some content]]<InsertVar Name="FN_1" Value=""/><![CDATA[]]</ParagraphStyle>
                <ParagraphStyle Style="NormalParagraphStyle"><![CDATA[More content]]<CharacterStyle Style="Super"><InsertVar Name="FN_2" Value=""/></CharacterStyle></ParagraphStyle>
                <ParagraphStyle Style="NormalParagraphStyle"><![CDATA[And even more content]]<InsertVar Name="FN_3" Value=""/></ParagraphStyle>
              </Flow>
            </Flows>
          </Document>
        </Documents>
      </Book>
    </Books>
  </Project>
  
```

This will create the following document:

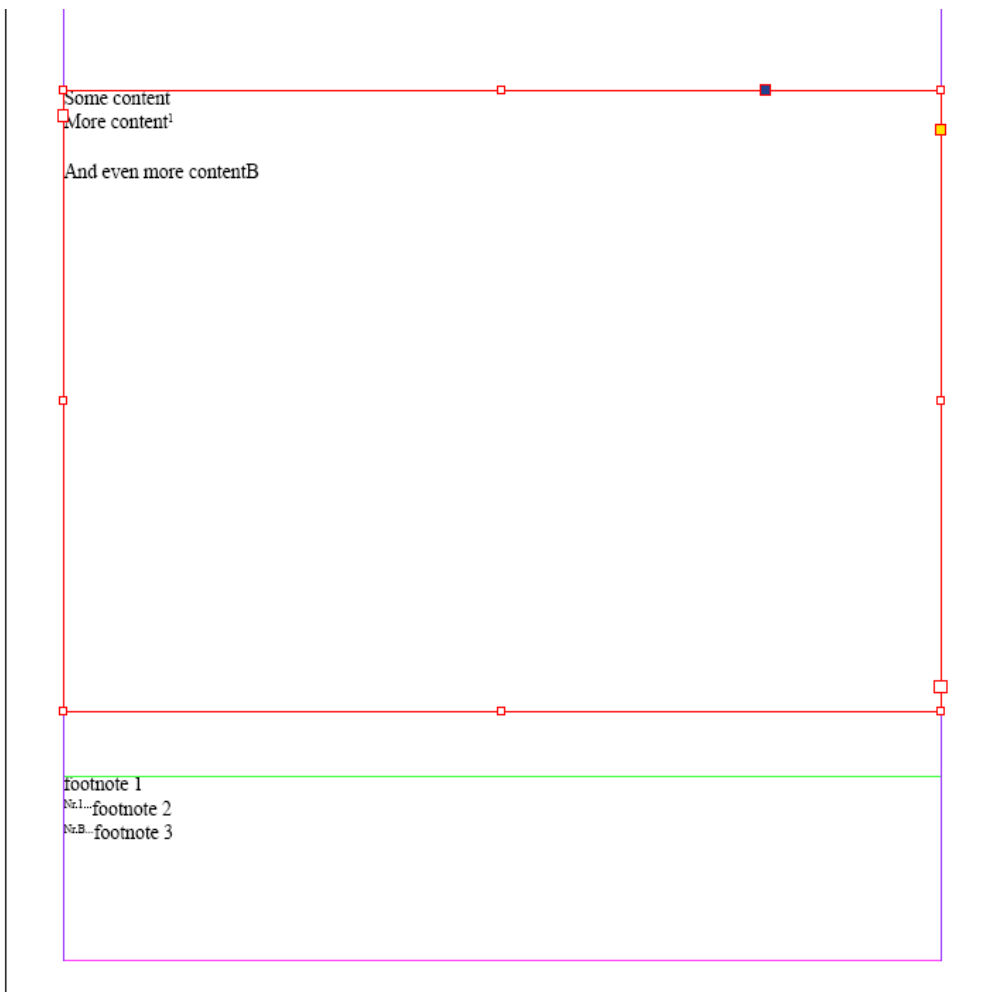

## Chapter 9

### Style Elements

The style settings can be stored inside the master document. They can also be defined in XML. The XML values overrule the settings in the master. These style settings are documented in this chapter.

This chapter contains the following sections:

- Preferences
- Colors
- Layer Element
- Style Element

## 9.1 Preferences

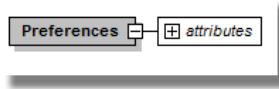

### Preferences

Attribute	Def <sup>a</sup>	Value(s)	Def. value	Explanation/examples
SuperScriptPos	I			In points
SuperScriptSize	I			In points
SubScriptPos	I			In points
SubScriptSize	I			In points

a.R=Required, I=Implied



## 9.2 Colors

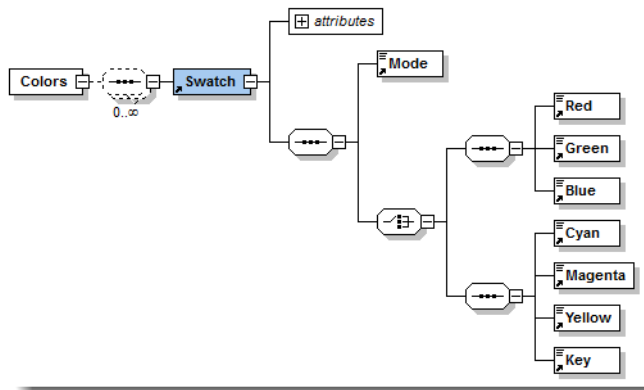

### Swatch

Attribute	Def <sup>a</sup>	Value(s)	Def. value	Explanation/examples
Name	R			The name of the swatch
Mode	R	RGB CMYK		Color mode
Red	R	0-255		Integer
Green	R	0-255		Integer
Blue	R	0-255		Integer
Cyan	R	0-100		Integer
Magenta	R	0-100		Integer
Yellow	R	0-100		Integer
Key	R	0-100		Integer

a.R=Required, I=Implied

### 9.3 Layer Element

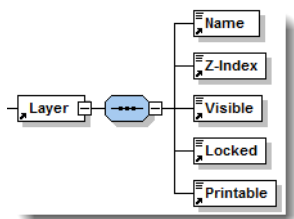

#### Layer

Attribute	Def <sup>a</sup>	Value(s)	Def. value	Explanation/examples
Name	R			The name of the layer. If it does not exist, it will be created.
Z-Index	R			The z-index of this layer. If unknown, just use any value like 0 or 1.
Visible	R			The layer is visible or not.
Locked	R			The layer is locked or not.
Printable	R			The layer is printable or not.

a.R=Required, I=Implied

## 9.4 Style Element

### Character Styles/Paragraph/Table/Cell styles

Attribute	Def <sup>a</sup>	Value(s)	Default Value	Explanation/examples
BalanceLines		True False		Balance ragged lines
BaselineShift				The BaselineShift.
BorderColor				Border color for table or cell styles.
BorderGapColor				Border gap color for table or cell styles.
BorderGapOverprint				Border gap overprint for table or cell styles.
BorderGapTint				Border gap tint for table or cell styles.
BorderOverprint				Border overprint for table or cell styles.
BorderTint				Border tint for table or cell styles.
BorderType				Border type for table or cell styles.
BorderWeight				Border weight for table or cell styles.
Bullets		BulletChar TextAfter CharStyle Number ContinueFromPrevious StartAt		The bullets for paragraph or character styles.
Case				The case for paragraph or character styles.
CharacterColor	R R R R R R	FillOverprint FillTint StrokeColor StrokeOverprint StrokeTint StrokeWeight		Used for the Character Color tab.
Clipping				Clipping for table or cell styles.
ColumnStrokes		FirstCount FirstWeight FirstType FirstColor FirstTint FirstOverprint FirstGapColor FirstGapTint FirstGapOverprint NextCount NextWeight NextType NextColor NextTint NextOverprint NextGapColor NextGapTint NextGapOverprint SkipFirst SkipLast		The ColumnStrokes tab of the table styles.
DiagnolColor				Diagnol color type for table or cell styles.
DiagnolGapColor				Diagnol gap color for table or cell styles.
DiagnolGapOverprint				Diagnol gap overprint for table or cell styles.
DiagnolGapTint				Diagnol gap tint for table or cell styles.
DiagnolLine				Diagnol line for table or cell styles.
DiagnolOverprint				Diagnol overprint for table or cell styles.
DiagnolsOnTop				Diagnols on top for table or cell styles.
DiagnolStrokeType				Diagnol stroke type for table or cell styles.

## Character Styles/Paragraph/Table/Cell styles

Attribute	Def <sup>a</sup>	Value(s)	Default Value	Explanation/examples
DiagnolTint				Diagnol tint for table or cell styles.
DiagnolWeight				Diagnol weight for table or cell styles.
FillColor				Fill color for table or cell styles.
FillOverprint				Fill overprint for table or cell styles.
Fills	R R R R R R R R R R R	Pattern FirstCount FirstColor FirstTint FirstOverprint NextCount NextColor NextTint NextOverprint SkipFirst SkipLast		The Fills tab of the table styles.
FillTint				Fill tint for table or cell styles.
FirstBaselineMin				First baseline minimum for table or cell styles.
FirstBaselineOffset				First baseline offset for table or cell styles.
FirstLineIndent				The indent for the first line.
FontColor				The font color for paragraph or character styles. The hex. Value of the RGB color values (for example #29292D) or the name of a swatch.
FontFamily				The name of the font family for paragraph or character styles.
FontSize				The font size (points) for paragraph or character styles.
FontStyle				The font style for paragraph or character styles.
HorizontalAlignment				The horizontal alignment for paragraph or character styles.
HorizontalScale				The HorizontalScale (Advanced Character Formats).
Hyphenation	R R R R R R R R R R	Capitalized Ladder LastWord Limit Zone CrossColumn AfterFirst BeforeLast ShortestWord Mode		Used for the Hyphenation tab.
InsetBottom				Inset bottom for table or cell styles.
InsetLeft				Inset left for table or cell styles.
InsetRight				Inset right for table or cell styles.
InsetTop				Inset top for table or cell styles.
Justification	R R R R R R R R R R R	WordSpaceMin WordSpaceMax WordSpaceDes GlyphsScaleMin GlyphsScaleMax GlyphsScaleDes LetterspaceMin LetterspaceMax LetterspaceDes AutoLeading SingleWordJustification		Used for the Justification tab.
Kerning				The Kerning (Basic Character Formats).
Language		See note at the end of this table		The language used for determining hyphens.
LastLineIndent				The indent for the last line.

## Character Styles/Paragraph/Table/Cell styles

Attribute	Def <sup>a</sup>	Value(s)	Default Value	Explanation/examples
Leader	R	CharValue		
LeftIndent				The left indent for paragraph or character styles.
LetterSpacing				The letter spacing for paragraph or character styles.
Ligatures				The Ligatures (Basic Character Formats).
LineHeight				The line height for paragraph or character styles.
NoBreak				The No Break (Basic Character Formats).
Position				The position for paragraph or character style
RightIndent				The right indent for paragraph or character styles.
RowStrokes	R R	FirstCount FirstWeight FirstType FirstColor FirstTint FirstOverprint FirstGapColor FirstGapTint FirstGapOverprint NextCount NextWeight NextType NextColor NextTint NextOverprint NextGapColor NextGapTint NextGapOverprint SkipFirst SkipLast		The RowStrokes tab of the table styles.
RuleAbove	R R R R R R R R R R R R R R R R R R R	RuleOn StrokeWeight StrokeType StrokeColor StrokeTint StrokeOverprint GapColor GapTint GapOverprint Width Offset LeftIndent RightIndent KeepInFrame		The ParagraphRules tab of the paragraph styles.
RuleBelow	R R R R R R R R R R R R R R R	RuleOn StrokeWeight StrokeType StrokeColor StrokeTint StrokeOverprint GapColor GapTint GapOverprint Width Offset LeftIndent RightIndent		The ParagraphRules tab of the paragraph styles.
SkewAngle				The skew angle for the characters.
SpaceAfter				Space after table for table styles.
SpaceBefore				Space before table for table styles.

## Character Styles/Paragraph/Table/Cell styles

Attribute	Def <sup>a</sup>	Value(s)	Default Value	Explanation/examples
Strikethrough	R R R R R R R R R	Weight Type Offset Color Tint StrokeOverprint GapColor GapTint GapOverprint		Strike through yes or no for paragraph or character styles.
StrokeColor	R R R R	Left Top Right Bottom		Stroke Color for table or cell styles. When value is inserted for element this will overrule the values set with the attributes.
StrokeGapColor	R R R R	Left Top Right Bottom		StrokeGapColor for table or cell styles. When value is inserted for element this will overrule the values set with the attributes.
StrokeGapOverprint	R R R R	Left Top Right Bottom		StrokeGapOverprint for table or cell styles. When value is inserted for element this will overrule the values set with the attributes.
StrokeGapTint	R R R R	Left Top Right Bottom		StrokeGapTint for table or cell styles. When value is inserted for element this will overrule the values set with the attributes.
StrokeOverprint	R R R R	Left Top Right Bottom		StrokeOverprint for table or cell styles. When value is inserted for element this will overrule the values set with the attributes.
StrokeTint	R R R R	Left Top Right Bottom		StrokeTint for table or cell styles. When value is inserted for element this will overrule the values set with the attributes.
StrokeType	R R R R	Left Top Right Bottom		Stroke type for table or cell styles. When value is inserted for element this will overrule the values set with the attributes.
StrokeWeight	R R R R	Left Top Right Bottom		Stroke weight for table or cell styles. When value is inserted for element this will overrule the values set with the attributes.
Tab (Leader?)	R R R R	LeaderCount Alignment AlignToChar Position		
Tabs (Tab)				For the Tabs tab.
TextRotation				Text rotation for table or cell styles.
Tracking				The tracking (Basic Character Formats).
Underline	R R R R R R R R R	Weight Type Offset Color Tint StrokeOverprint GapColor GapTint GapOverprint		Underline yes or no for paragraph or character styles.
VerticalJustification				Vertical justification for table or cell styles.
VerticalScale				The VerticalScale (Advanced Character Formats).
VJSpacingLimit				Vertical justification spacing limit for table or cell styles.

a.R=Required, I=Implied

## Language Values

Language in InDesign	Internal value to use in XML
English UK:	English: UK
Bulgarian:	Bulgarian
Catalan:	Catalan
Croatian:	Croatian
Czech:	Czech
Danish:	Danish
Dutch: 2005 Reform	nL_NL_2005
Dutch: Old Rules:	Dutch
English Canadian:	English: Canadian
English USA	English: USA
English: USA Legal	English: USA Legal
English: USA Medical	English: USA Medical
Estonian	Estonian
Finnish	Finnish
French	French
French: Canadian	French: Canadian
German: Reformed	German: Reformed
German 2006 Reform	de_DE_2006
German Old Rules	German: Traditional
German: Swiss	German: Swiss
German: Swiss 2006 Reform	de_CH_2006
Greek	Greek
Hungarian	Hungarian
Italian	Italian
Latvian	Latvian
Lithuanian	Lithuanian
Norwegian: Bokmal	Norwegian: Bokmal
Norwegian: Nynorsk	Norwegian: Nynorsk
Polish	Polish
Portuguese: Orthographic	Orthographic Agreement
Portuguese	Portuguese
Portuguese: Brazilian	Portuguese: Brazilian
Romanian	Romanian
Russian	Russian
Slovak	Slovak
Slovenian	Slovenian
Spanish	Spanish: Castilian
Swedish	Swedish
Turkish	Turkish
Ukrainian	Ukrainian

## Chapter 10

### Special Elements

This chapter describes special elements.



## 10.1 Variable Element

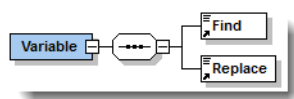

### Variable

Attribute	Def <sup>a</sup>	Value(s)	Default Value	Explanation/examples
Find				Find value
Replace				Replace with value

a.R=Required, I=Implied

The variable element allows you to set the variable contents (variable of the type “Custom Text”). Be aware that it does not create a variable if it does not exist in the master document, it only sets the content.

To create a variable in the master document:

1. Select **Type, Text Variables, Define** from the InDesign main menu:

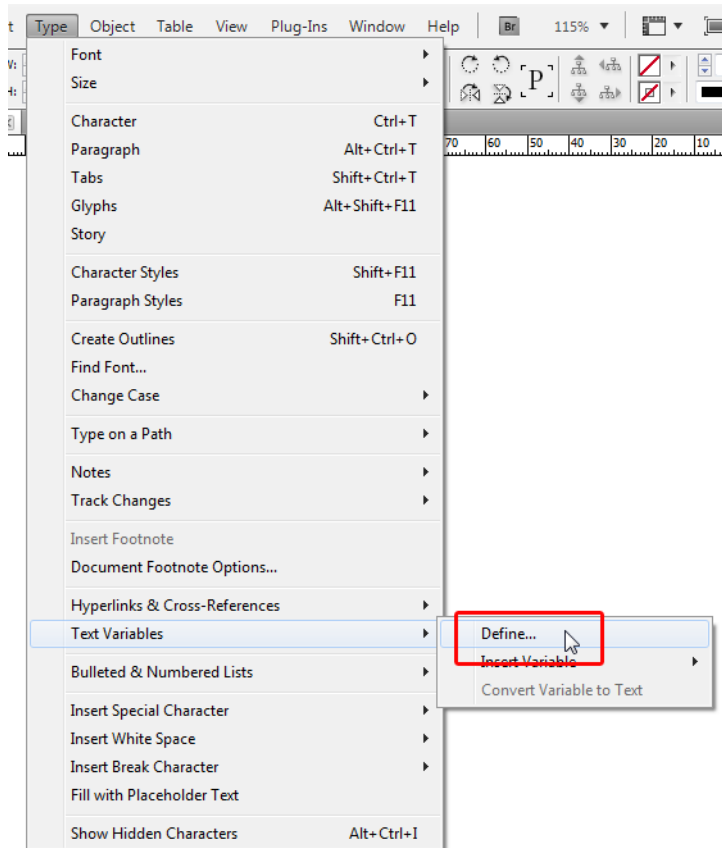

The **Text Variables** dialog is displayed:

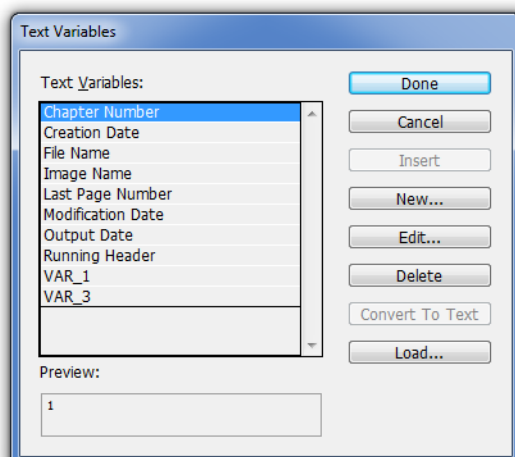

2. Click **New**. The “New Text Variable” is displayed:

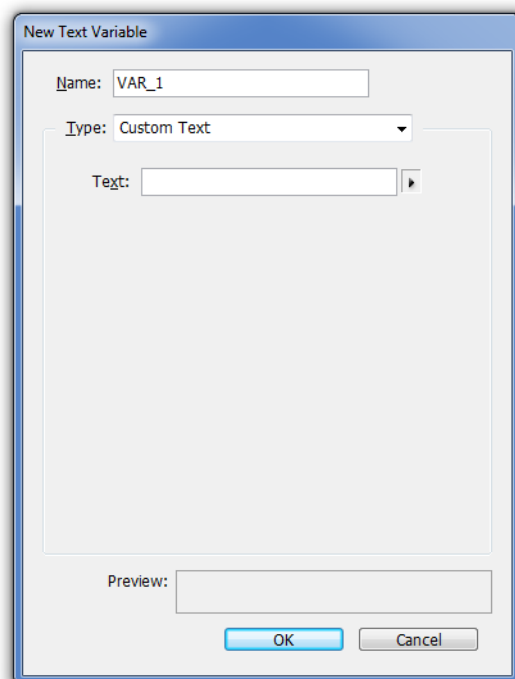

3. Select the **Custom Text** as a type and fill in the **Name** field with the value that corresponds to the name value of your **Find** element in the XML.

```
<Variables>
  <Variable>
    <Find>VAR_1</Find>
    <Replace>this is VAR_1</Replace>
  </Variable>
</Variables>
```

A variable can be inserted in the content by using the **InsertVar** element. To illustrate how both work together:

```

1  <?xml version="1.0" encoding="UTF-8" standalone="yes"?>
2  <Project>
3    <Books>
4      <Book BookFilename="" ExportPDF="False" PrintBook="False">
5        <Documents>
6          <Document Type="Dynamic" MasterFilename="c:\temptests\VARSmaster.indd" DocFilename="c:\temptests\VARs_test.indd" PageWidthI
7            <Variables>
8              <Variable>
9                <Find>VAR_1</Find>
10               <Replace>this is VAR_1</Replace>
11             </Variable>
12           </Variables>
13         <Pages>
14           <Page MasterPrefix="A" MasterBase="Master" Number="3">
15             <TextFrame Width="200" Height="200" X="120" Y="120" Z-Index="0">
16               <ParagraphStyle Style="P_ProductGroup">Some content</ParagraphStyle>
17               <ParagraphStyle Style="Body">create var in content: <InsertVar Name="VAR_3" Value="this is VAR_3"/></ParagraphStyle>
18               <ParagraphStyle Style="Body">use var 1: <InsertVar Name="VAR_1" Value=""/></ParagraphStyle>
19               <ParagraphStyle Style="Body">and var 3 again: <InsertVar Name="VAR_3" Value=""/></ParagraphStyle>
20               <ParagraphStyle Style="Body">creation date var: <InsertVar Name="VAR_X" Value=""/></ParagraphStyle>
21               <ParagraphStyle Style="Body">other var: <InsertVar Name="VAR_X1" Value="test"/></ParagraphStyle>
22             </TextFrame>
23           </Page>
24         </Pages>
25       </Document>
26     </Books>
27   </Project>
28
29
30

```

In this sample XML we set the value of the VAR\_1 variable to “this is VAR\_1”. In the content we use the “InsertVar” element to create a new variable called “VAR\_3”. We then insert the variable “VAR\_1”. Then we insert the “VAR\_3”. Then we insert the variable “VAR\_X”, which corresponds to a variable of the type “Creation date” in the master. And finally we create a new variable called “VAR\_X1” and set the value of that variable to “test”.

This would result in:

